

An exploded view of a white plastic fluid warmer device. The device consists of a main rectangular body with a lid on top and a base on the bottom. The lid is shown partially open, revealing a dark rectangular opening. The base is also shown partially open, revealing internal components including a small rectangular module with two circular ports. The device is shown in a clean, minimalist setting with a light gray background.

Low-Cost Fluid Warmer
Thesis by Marjolein van der Male



FIELD READY



UNIVERSITY OF
APPLIED SCIENCES

Thesis by
Marjolein van der Male

Internship at
Field Ready Nepal
Nepal Innovation Lab, Kathmandu

Field Ready guidance by
Abi Bush
Global Technical Adviser
abi.bush@fieldready.org

Bachelor program
Industrial Design and Engineering
Rotterdam university of applied sciences, Rotterdam

Guidance from school by
Bartel Hulst
h.t.p.hulst@hr.nl

Table of contents

1. Summary.....	6	5.4 Sub question 2 – What is available on the market?.....	14
2. List of abbreviations and glossary	7	5.4.1 Introduction	14
3. Background.....	8	5.4.2 Method.....	14
3.1 Introduction.....	8	5.4.3 Results	14
3.2 Nepal	8	5.4.4 Conclusion	19
3.3 Field Ready	8	5.5 Sub question 3 – Which technical principles can be used to warm blood?	19
3.4 Annapurna Neurological Institute	8	5.5.1 Introduction	19
4. Problem definition.....	9	5.5.2 Method.....	19
4.1 What is the problem?	9	5.5.3 Results	19
4.1.1 How often does this problem occur?	9	5.5.4 Conclusion	20
4.2 Current solution	9	5.6 Sub questions 4 – Where will the fluid warmer be used?	21
4.3 Desired solution.....	9	5.6.1 Introduction	21
4.4 5W2H.....	10	5.6.2 Method.....	21
4.5 Risk assessment.....	11	5.6.3 Results	21
5. Research	12	5.6.4 Conclusion	22
5.1 Introduction.....	12	5.7 Sub question 5 – Which heating elements are is available?	22
5.2 Research questions.....	12	5.7.1 Introduction	22
5.3 Sub question 1 – How do blood transfusions work?.....	12	5.7.2 Method.....	22
5.3.1 Introduction.....	12	5.7.3 Results	22
5.3.2 Method	12	5.7.4 Conclusion	23
5.3.3 Results	12	5.8 Sub question 6 – How can the fluid warmer be made?	24
5.3.4 Conclusion	13	5.8.1 Production technique.....	24

5.8.2	Materials.....	24	7.5.4	Test.....	60
5.8.3	Conclusion	25	7.5.5	Safety features	60
6.	Requirements	26	7.5.6	Conclusion	60
7.	Design.....	33	7.6	Subproblem 4: User interface	61
7.1	Introduction.....	33	7.6.1	Introduction	61
7.2	Main and subproblems.....	33	7.6.2	Sketches	61
7.3	Subproblem 1: How hot would the fluid warmer need to be to heat the fluids to 37°C in 25 cm?	34	7.6.3	Design choices.....	61
7.3.1	Introduction.....	34	7.6.4	Feedback	62
7.3.2	Formulas.....	34	7.6.5	Adjustments	62
7.3.3	Calculations	35	7.7	Subproblem 6: IV stand connection.....	63
7.3.4	Conclusion	42	7.7.1	Introduction	63
7.4	Subproblem 2: IV Line layout	43	7.7.2	Sketches	63
7.4.1	Introduction.....	43	7.7.3	3D-CAD	64
7.4.2	Heating element.....	43	7.7.4	Prototype	65
7.4.3	Metal plate	44	7.7.5	Test & Feedback.....	66
7.4.4	Materials and manufacturing.....	56	7.7.6	Adjustments	68
7.4.5	Conclusion	56	7.7.7	Materials & Manufacturing.....	68
7.5	Subproblem 3: Electronics.....	57	7.7.8	Conclusion.....	68
7.5.1	Introduction.....	57	7.8	Housing construction	69
7.5.2	Components	57	7.8.1	Introduction	69
7.5.3	Block diagram	58	7.8.2	Casing 1	69
	58	7.8.3	Casing 2	81
	58	7.8.4	Materials & manufacturing.....	84

7.8.5	Technical drawings	84
7.8.6	Conclusion	84
7.9	Assembly.....	85
8.	Verification	87
8.1	Introduction.....	87
8.2	Cost analysis	87
8.3	Electromagnetic interference (EMI)	88
8.4	Open source availability	88
8.5	The field ready fluid warmer must be ready for use (35.2°C) in 189 seconds or less.....	89
8.5.1	Introduction.....	89
8.5.2	Formulas	89
8.5.3	Calculations	89
8.5.4	Conclusion	89
8.6	Checklist requirements.....	90
9.	Conclusion and recommendation	96
10.	Reflection.....	97
	Bibliography.....	98

1. Summary

The goal of this graduation thesis is to design a low-cost fluid warmer. This is a medical device that warms blood and other liquids that are to be transfused to prevent hypothermia in weak patients. This is done by doing research on various ways of warming fluids and getting to know more about blood transfusions, followed by making multiple variations of a design and verifying these designs.

This research and design process was done in Kathmandu, Nepal, with Field Ready. Local hospital Annapurna Neurological Institute was the main stakeholder of this project. The design was made to be low-cost, and for anyone to be able to put together. The design will become available on open source websites. The design was made to be manufactured with parts and production techniques available in Nepal.

It was concluded that it is possible to design a low-cost fluid warmer as the design meets most requirements set in this thesis, however, multiple tests still need to be done before the fluid warmer should be used to warm human blood in a hospital setting.

2. List of abbreviations and glossary

AHF – anti-haemophilic factor – This is a blood-clotting protein. When an injury of a blood vessel occurs, this protein, together with other factors, forms a blood clot to fix the damage.

ANI – Annapurna Neurological Institute

Cryoprecipitate – A blood product made from fresh frozen plasma. After centrifugation the precipitate is collected.

Er. – Nepali abbreviation for engineer

FDM – Fused deposition modelling – a form of 3D-printing

Haemolysis – The destruction of red blood cells

ICU – Intensive care unit

IV – intravenous

NGO - non-governmental organisation

NPR – Nepalese Rupees

Temp – temperature

3. Background

3.1 Introduction

The low-cost fluid warmer is a project that was established as high priority project by performing a needs-assessment in Annapurna Neurological Institute in Kathmandu (ANI), Nepal. This needs assessment can be found in appendix pg. 6. A proposal was written to ensure cooperation of ANI. This can be found in appendix pg. 9. Kathmandu is also the place where this graduate internship has taken place from September 2017 till January 2018 with a not for profit organization called Field Ready.

3.2 Nepal

Nepal is a mostly Hindu country between India and China in south-Asia with a population of 29 million. Nepal houses 8 of the 10 highest mountains in the world, but also has hills and flatlands. The main language spoken in Nepal is Nepalese. Nepal is one of the poorest countries in the world.

3.3 Field Ready

Field Ready is a non-governmental organisation (NGO) that provides humanitarian aid by developing products that can be made and used in the field. The main focus of Field Ready is 3D-printing. Field Ready works in multiple countries around the world including Nepal, Haiti, USA, Syria and Jordan.

3.4 Annapurna Neurological Institute

Annapurna Neurological institute (ANI) is a private hospital located in Kathmandu Nepal. This hospital specialises in neurosurgery. The hospital was founded in 2009 by doctor Basant Pant, who is a leading neurosurgeon in Nepal. Figure 1 shows a collage of pictures taken at ANI.



Figure 1 - Annapurna Neurological Institute

4. Problem definition

4.1 What is the problem?

When an emergency situation occurs during surgery, a blood transfusion is often needed to replace lost blood and stabilize the patient. However, blood is stored refrigerated. To prevent hypothermia and side effects of hypothermia in this situation the blood needs to be warmed. This applies during emergency blood transfusions, and furthermore to transfusions of other fluids that may not be classified as an emergency situation. The way blood is warmed at the moment is unsafe. Blood and fluid warmers exist on the international market, but ANI cannot afford to buy one.

4.1.1 How often does this problem occur?

In ANI this problem occurs 3 or 4 times a month. However, in hospitals with an emergency room the problem occurs more often (Interview with Er. Sonam Subba, 19-09-2017, appendix pg.11).

4.2 Current solution

The current solution that ANI uses to warm blood in emergency situations is to use a warm water bath. They submerge the unit of blood in a bath of warm water. It takes about 10 minutes to heat blood this way (Interview with Er. Sonam Subba, 19-09-2017, appendix pg.11). Warming blood in hot water can cause haemolysis (the destruction of red blood cells (Medical Dictionary, 2017)). Haemolysis can be life-threatening (World Health Organization Blood Transfusion Safety, 2002).

ANI has attempted to make a fluid warmer themselves (figure 2 and 3). This fluid warmer has a heating element that can go up to 110°C with no safety precautions. This heating element is insulated with cardboard.

4.3 Desired solution

The desired solution for this problem is a fluid warmer that can warm blood and other liquids to an acceptable temperature to prevent hypothermia while transfusing at low cost.



Figure 2 - Outside of ANI's fluid warmer



Figure 3 - Inside of ANI's fluid warmer

4.4 5W2H

Using the 5W2H method in Figure 4, prior knowledge was charted.

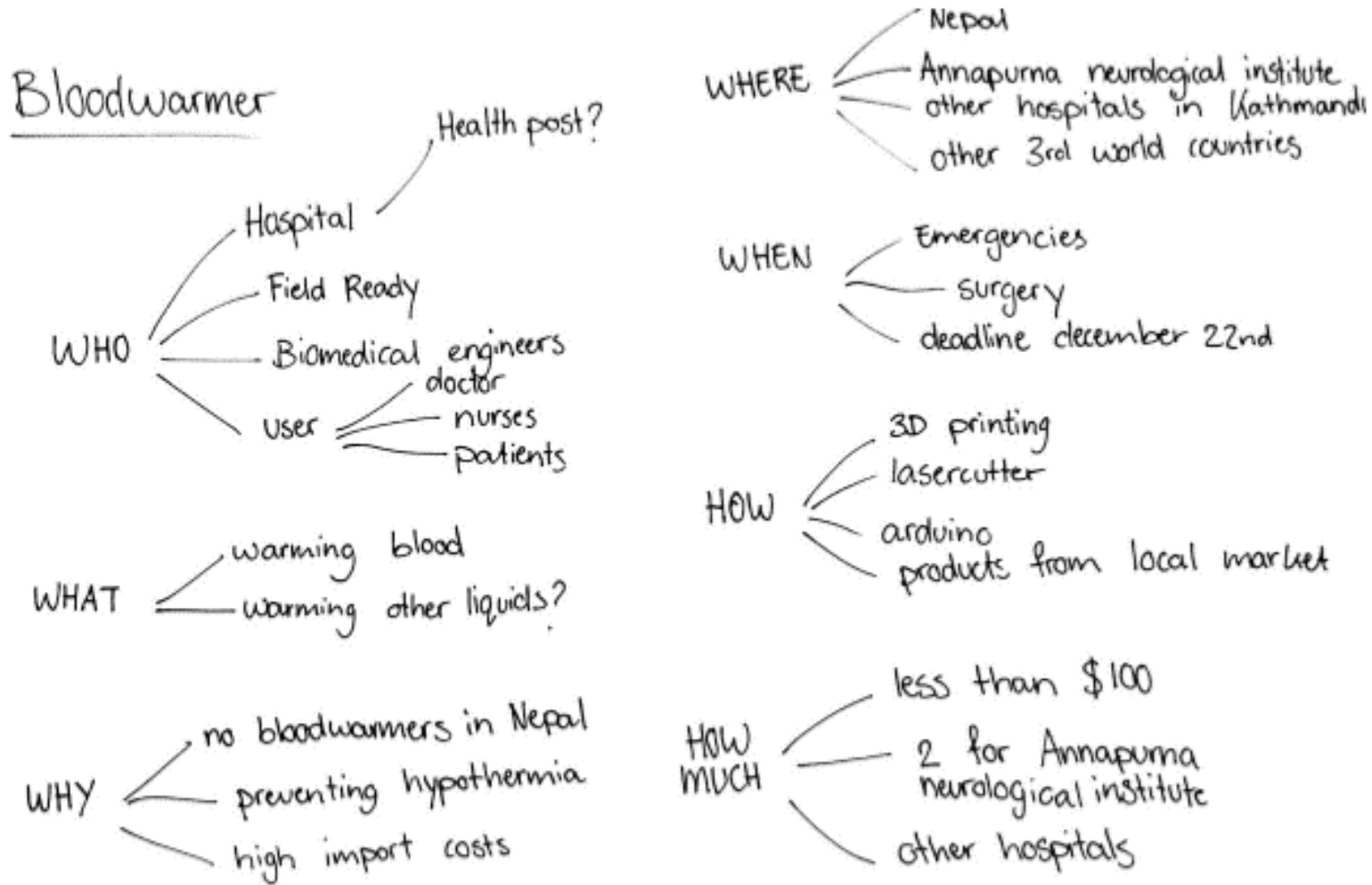

Figure 4 - 5W2H Brainstorm

4.5 Risk assessment

A risk assessment was conducted to see what the benefits and risks are of this project. Table 1 shows a basic risk assessment with positives and negatives, and table 2 shows a more in-depth risk analysis.

These risk assessment where done to evaluate if this project was worth undertaking or if the risks where too big for Field Ready to find acceptable.

Field Ready has found the risk acceptable, however, this project will be classed as a very high risk due to the possibility of serious injury and death.

Current situation/baseline	Field Ready Solution
Positive Outcomes	Positive Outcomes
Virtually no cost	Warms blood safely
Warms blood	Low risk of haemolysis due to alarm systems
	Cheap alternative to expensive equipment
	Safety precautions have been taken
	Fulfils standard specifications for fluid warmers
	Saves 3 to 4 lives a month
Negative Outcomes	Negative Outcomes
Slow process (especially in emergencies)	Field Ready reputation could be damaged if it malfunctioned
The blood is not warmed safely	Could malfunction and overheat blood
High risk of haemolysis (could result in death)	

Table 1 - Positives and negatives of the current situation and a new solution

Risk identification				Risk Evaluation		
#	Negative outcome	Hazard	Possible Accident	Risk Control	Severity (1 - 5)	Likelihood (1 - 5)
1	Death	Overheating blood	X	Audible and visual alarm	5	1
2	Hypothermia	Not heating blood enough	X	Display with temperature	2	3
3	Hypothermia	Malfunction (device not working)	Battery runs out	Mechanical failsafe	2	2
4	Haemolysis	Alarm system malfunctioning	X	Test as device turns on/ mechanical failsafe	5	2
5	Burn	Heating element	Doctor/nurse touching heating element	Caution sign	1	3
6	Pain (possibly death)	Electrocution	The wiring is not installed right	Detailed instruction document	5	2

Table 2 - Risk Identification and evaluation

5. Research

5.1 Introduction

This chapter will showcase the research that has been done to get a greater understanding of the requirements the fluid warmer should comply with. It also shows what fluid warming products are available on the international market and how transfusions are performed.

5.2 Research questions

Main question:

Is it possible to develop a low-cost fluid warmer that can be manufactured in Nepal, and is available on open source websites?

Sub questions:

How do blood transfusions work?

What is available on the market?

How does a fluid warmer work?

Where will the fluid warmer be used?

Which heating element should be used?

How can the fluid warmer be manufactured?

5.3 Sub question 1 – How do blood transfusions work?

5.3.1 Introduction

To know how a fluid warmer is implemented it is important to understand how blood transfusions are carried out. This information is the background knowledge to this project.

5.3.2 Method

- Literature study
- Observation
- Interview

5.3.3 Results

Why do patients receive blood transfusions?

The main reason for blood transfusions are during a major surgery, patients with serious injuries and patients with an illness that can cause anaemia (Red Cross, Reasons People Recieve Blood Transfusions, 2017). Paragraph 5.6.3 provides a more specific breakdown.

A patient in ANI will receive a blood transfusion if their haemoglobin levels are below 8 g/dl (Er. Kishor Bhandari, 11-10-2017, log, appendix pg.4). This conforms with the standard for critically ill patients, who get a transfusion if their haemoglobin level is in the range of 8-8.5 g/dl (Samir M Fakhry, 2004).

Protocol for blood transfusions

The protocol for blood transfusions is broken down in 8 steps (AM Harris, 2012).

1. Get the patients consent

The patient should be informed of all the benefits and risks of receiving a transfusion. In an emergency situation, where the patient is not capable of giving consent, a choice must be made in the patient's best interests.

2. Identify the patient

All patients receiving a transfusion must be identified before proceeding. This can be done via the wristband that is attached to the patients' wrist.

3. Prescribing the blood

A prescription of a doctor is needed to transfuse blood.

4. Testing patients' blood samples

A blood sample must be tested to make sure the patient and donor are compatible. Labelling this sample correctly is very important.

5. Requesting the blood

The request must include patient information, the diagnosis of the patient and relevant procedures. The request may be done by medical and non-medical staff. Staff identification of the staff member making the request must also be included in the request.

In emergency situations when there is no time for testing of blood samples, the patient will receive a unit of O-negative.

6. Preparing the patient and collecting the blood

The patient must be ready to receive the transfusion. Check patient information and make sure the right blood is being collected.

7. Start the transfusion

Final check making sure the patient is receiving compatible blood.

8. Monitoring the patient

The patient's pulse, temperature, blood pressure and respiratory rate must be monitored. Starting with a baseline. If there is significant change after 15 minutes, stop the transfusion. Monitor the patient the next 24 hours.

(AM Harris, 2012)

At Annapurna neurological institute there is no transfusion protocol in place (Dr. Basant Pant, 13-10-2017, log, appendix pg. 4) (Er. Kishor Bhandari, 10-10-2017, log, appendix pg. 4). They do however follow transfusion guidelines (Dr. Basant Pant, 13-10-2017, log, appendix pg.4).

Where would a fluid warmer fit in?

Depending on which type of fluid warmer is used, the unit of blood will be warmed in a water bath before being administered, or the fluid warmer will be added onto the IV-line before going directly into the patient.

Flowrate

During a rapid infusion, which may happen during an emergency situation or surgery, the infusion rate can range from 6000 to 30000 ml/h (AM Harris, 2012). This is however not very common during neurosurgery. The maximum flowrate of the fluid warmer may therefore be 6000 ml/h.

5.3.4 Conclusion

ANI does not have a blood transfusion protocol. A protocol is recommended for safe and efficient blood transfusion.

Requirements:

- The field ready fluid warmer must be able to heat blood at a flow rate of 6000 ml/h (100 ml/min).

5.4 Sub question 2 – What is available on the market?

5.4.1 Introduction

A fluid warmer is a medical device that is already available on the market. In the following chapter the fluid warmers that are available will be listed. The types of fluid these devices can warm will also be listed.

5.4.2 Method

- Literature
- Interview
- Market research
 - Brand
 - Price
 - Heating technique
 - Accuracy
 - Minimum temperature
 - Maximum temperature
 - Maximum flow rate
 - Heating time

5.4.3 Results

Fluid warmers in Nepal

There are no fluid warmers available on the market in Nepal. Fluid warmers can be imported (dr. Basant Pant, 13-10-2017, log, appendix pg.4).

Import costs





The cost of importing medical equipment into Nepal is very high. To the cost of the product, the following is added:





20% for the international Distributor
20% for the regional distributor, located in Singapore
20% for the Indian distributor
20% for the Nepali distributor
(Dr. Basant Pant, 13-10-2017, log, appendix pg.4)

The price of all imported medical equipment increases by 80%.

To be able to import in Nepal a bribe is needed for a custom agent; “no bribe, no import”. The legal cost of paying the custom agent is 585 NPR (Nepalese Rupees), but they will ask a minimum of 5000 NPR (\$50). Depending on the value of the product being imported, the price will go up (Ram Chandra Thapa, 07-11-2017, log, appendix pg.4).

Fluid warmers on the international market

	Name	Brand	Heating method	Power	Accuracy	Min temp	Max temp	Max flowrate	Price	Price after importing	Heating time
	Astotherm 220/220S/260/260S	Stihler Electronic	Dry heat	230/240 V	selectable 39/41/43°C	39°C	43°C	2500 ml/h	\$6278.23	\$11300.81	120 seconds
	Belmont Buddy Lite	Belmont	Dry heat	100-240V	+/- 2°C	36°C	40°C	Input 20°C 4800 ml/h Input 10°C 3000 ml/h	\$4017.00	\$7230.60	x
	Protherm 2	Biegler Medizin Elektronik	Dry heat	230V	0.5°C	37°C	41°C	Massive transfusion	x	x	40 seconds
	BFW1020B	Ebestman	Dry heat	230V	+/- 0.5°C	28°C	41°C	9000 ml/h	\$940.50	\$1692.90	x

	Name	Brand	Heating method	Power	Accuracy	Min temp	Max temp	Max flowrate	Price	Price after importing	Heating time
	BFW-1000+ Infusion Warmer	Ebestman	Dry heat	230V	+/- 1°C	28°C	41°C	900 ml/h	\$399.00	\$718.20	60 seconds
	BTM-8	Biobase	Water bath	AC220/110V	+/- 0.5°C	37°C	37.5°C	x	\$1000	\$1800	720 seconds
	Level 1 [®] H-1200 Fast Flow Fluid Warmer	Smiths Medical	Counter current water bath	230V	x	37°C	42°C	x	\$299 used	\$538.20	x
	Thermostat 900 T900	Paladin Bio-medical	In-line Micro-wave	230V	+/- 1°C	x	40°C	58200 ml/h	x	x	5 seconds

Market placement

Field Ready wants the fluid warmer to be easily accessible. After discussion with the Field Ready team (27-09-2017, LOG, appendix pg.4) there was decided that the price of the fluid warmer should not exceed \$75 US dollars. All Field Ready products are open source, and the fluid warmer should be to. \$75 is the maximum cost of all the parts, but does not include machines and tools needed and labour costs of assembling the fluid warmer. A drawback from having the end user manufacture the product is added risk of incorrect assembly and user malfunction.



Figure 5 Market placement

What fluids do these fluid warmers warm?

A fluid warmer warms fluids that are infused into the patient. Examples of fluids warmed are intravenous solutions, blood products and whole blood (Health Devices, 1996).

Intravenous solutions

Intravenous solutions are used to replace fluid losses, treat electrolyte imbalances and maintain fluid balances. Common IV fluid solutions are:

- Dextrose in water
- Saline
- Dextrose in saline
- Electrolyte solutions

(ATI nursing education, 2017)

Dextrose in water is stored at room temperature (25°C) (health.gov, 2017).

Saline is stored at room temperature (between 15°C and 30°C) (Ogbru, 2017).

Dextrose in saline is stored at room temperature (25°C) (Baxter Healthcare Corporation, 2017).

Electrolyte solutions are stored at room temperature (25°C) (Hospira, 2017).

Whole blood

The most common type of blood donation is whole blood (American Red Cross, Types of donations, 2017). Whole blood consists of red and white blood cells, platelets and plasma (Merriam-Webster Medical Dictionary, 2017). It is transfused during surgeries and in cases of trauma (American Red Cross, Blood Components, 2017). Whole blood is stored refrigerated

between 1°C and 6 °C (Requirements for Storage, Transportation and Expiration, 2016).

Blood products

There are four different transfusable components in whole blood. These components are red cells, platelets, plasma and cryoprecipitated AHF.

Red cells are used in cases of trauma, anaemia, surgery, blood loss and certain blood disorders. They are between 1°C and 6 °C.

Platelets are used during cancer treatments, organ transplants and trauma. They are stored between 20°C and 24°C with continuous gentle agitation.

Plasma is used in cases of shock, bleeding disorders and burn patients. It is stored frozen at -18°C or -65°C.

Cryoprecipitated AHF is used on patients with Von Willebrand disease, haemophilia and as a rich source of Fibrinogen. It is stored at -18°C.

(American Red Cross, Blood Components, 2017) (Requirements for Storage, Transportation and Expiration, 2016)

Annapurna neurological institute

At ANI the fluid warmer will be used to warm whole blood during blood loss in emergency situations and blood loss during surgeries. (interview with Er. Sonam Subba, 19-09-2017, appendix pg.11). During winter, the fluid warmer will also be used to warm intravenous solutions (dr. Basant Pant, 13-10-2017, log, appendix pg.4).

Testing

Whole blood and blood products are scarce. Therefore, in the initial testing phase, blood will be substituted with water. This is specified in the standard specification for fluid warmers. The minimum temperature the

fluids are stored at in 1°C, so this will be the start temperature for the tests.

An effort has been made to obtain animal blood for testing. Using blood for anything is not possible in Nepal due to cultural differences (Ram Chandra Thapa, 15-12-2017, log, appendix pg.4). There is no stigma to obtaining animal blood in The Netherlands, it is however subjected to a very short time frame in which it can be used. Animal blood (and pigs' blood) coagulates very quickly after butchering the animal and was therefore not available (Michiel, 05-01-2018, log, Appendix pg.5).

Heating time

The average heating time of the fluid warmers is $((120+40+60+5+720)/(5)) = 189$ seconds. This is the average over all types of fluid warmer. The average heating time of the dry heat fluid warmers is $((60+40+120)/(3)) = 73$ seconds.

The Field Ready fluid warmer should be able to match these times or be less.

5.4.4 Conclusion

To import a fluid warmer in to Nepal, the cost of the device would go up by at least 80%. For this reason, the device should be manufactured in Nepal.

ANI will use a fluid warmer to warm whole blood and saline solution. This will be done in emergencies and in the colder winter months.

Test will be executed with water.

Requirements:

- All parts needed to produce the fluid warmer must cost less than \$75 in total.
- The fluid warmer must be open source.
- Average heating time is 189 seconds $((120+40+60+5+720)/ (5)) = 189$ seconds). The Field Ready fluid warmer must be ready for use (35.2°C) in 189 seconds or less.
- The fluid warmer must be produced in Nepal to avoid 80% increase in price and \$50 import cost.
- The fluid warmer must be able to heat water from 1°C to 37°C
- The fluid warmer must be able to heat whole blood from 1°C to 37°C

5.5 Sub question 3 – Which technical principles can be used to warm blood?

5.5.1 Introduction

To understand how a fluid warmer works, research was done on different ways this is done in products that are available on the market.

5.5.2 Method

- Literature study

5.5.3 Results

What temperature should the transfusion be heated to?

Whole blood should be warmed to body temperature (37°C) (interview with Er. Sonam Subba, 19-09-2017, appendix pg.11). The American Association of Blood Banks limits the maximum temperature of blood warmers to 42°C (Herron DM, 1997).

Blood heating techniques

There are four common blood warming techniques.

- “Dry heat
- Counter current heat exchange
- Thermostatically controlled water bath
- In-line microwave”

(AABB, PDF: Guidelines for the use of blood warming devices, 2017)

Dry heat:

Dry heat is a technique that makes use of a heating element that heats the blood through the IV line and has no direct contact with the blood.

Counter current heat exchange:

This way of heating blood uses dry heat as well, but warming one side of the IV line and with this heated part of the IV line warming other parts of the IV line. This technique is derived from biomimicry of penguins' feet.

Thermostatically controlled water bath:

This technique is close to what ANI uses to heat blood now. It is however, safe and controlled. This technique includes a bath of water which is heated to a specific temperature.

In-line microwave:

In-line microwave is a heating technique that uses the same technique as a microwave to warm blood. This is a relatively new technique and there hasn't been much testing on negative effect of heating blood this way.

Dry heat is the most commonly used technique and can be made with heating elements on the market in Nepal.

Who operates the fluid warmer?

At ANI the fluid warmer will be operated by biomedical engineers (interview with Er. Sonam Subba, 19-09-2017, appendix pg.11). Blood transfusions are typically given by doctors and nurses (Red Cross, The Process, 2017), and Field Ready wants them to be able to use the fluid warmer as well.

5.5.4 Conclusion

There are 4 different methods of warming blood. Dry heat is one that can be replicated in Nepal.

The blood must be heated to 37°C and must never exceed 42°C.

The biomedical engineers at ANI would be using the fluid warmer, but if the product is simple enough to be used by doctors and nurses that would be a big plus.

- The fluid warmer must heat the fluid to 37°C
- The maximum temperature the fluid can be heated to must not exceed 42°C
- The fluid warmer warms blood via the heating technique "dry heat"
- Doctors and nurses must be able to use the fluid warmer after a 15-minute instruction session.

5.6 Sub questions 4 – Where will the fluid warmer be used?

5.6.1 Introduction

The main place the fluid warmer will be used is in ANI. This chapter shows where in the hospital the fluid warmer will be used, but also other hospitals where this product may or may not be useful.

5.6.2 Method

- Interview
- Observation

5.6.3 Results

In ANI the fluid warmer will be used in an operating theatre and ICU. The fluid warmer does not need to be sterile, but the surface should be easily cleanable (interview with Er. Sonam Subba, 19-09-2017, appendix pg.11). This may be different is the device is used in a 1st world country.

Using the fluid warmer in an operating theatre means that the fluid warmer should always be safe to handle. The outside temperature of the fluid warmer can be warm to the touch, but not hot. Insulation may be needed to stop the outside of the fluid warmer from heating too much.

The fluid warmer cannot be in direct contact with the fluids without complete sterilization of the parts that come in contact with the fluid. This can be possible by using an autoclave sterilizer, but 3D prints printed on a normal printer will never be completely sterile because of bacteria stuck between the layers. A sterile 3D printer printing in a sterile environment could achieve a completely sterile product. Field Ready does not want to take the risk of having blood in direct contact with a 3D print. This means the product will have to be an in-line fluid warmer. The fluid will be heated through the IV line.

Hospitals in Kathmandu often have reliable power and backup generators. In other hospitals and health posts outside of Kathmandu a reliable power source may not be available.

A needs assessment was conducted in a rural health post in a rural village in Sarlahi and the district hospital in Malangawa. The result of these needs assessment was that both are not in need of a fluid warmer. This is due to no adequate equipment in both places. The conditions in the hospital where so bad that people tend to avoid it in favour of a different hospital much further away. Figure 6 shows the hospital's emergency room. A report of this needs assessment can be found in appendix pg.12.



Figure 6 - Emergency room in Malangawa district hospital. There is no equipment to treat injuries.

5.6.4 Conclusion

The fluid warmer should be safe to handle, but in Nepal it is not necessary that the device is sterile.

The district hospital in Malangawa and the health post in Sarlahi had no need for a fluid warmer.

- Easily cleanable surface
- No direct contact with fluids
- Wish: The fluid warmer can work on different power sources.

5.7 Sub question 5 – Which heating elements are available?

5.7.1 Introduction

One of the most important components of the fluid warmer is the heating element. There are different kinds available on the Nepali market and this chapter delves into that.

5.7.2 Method

- Market research
- Test

5.7.3 Results

There are multiple heating elements available on the Nepalese market. Most heating elements are used for boiling water.

Heating element 1 (immersion heater)

This is the most commonly available heating element on the market. This is used to boil water. The average price is between €10 and €15. This heating element has a wattage of 1500W. Immersion heaters are on average 300mm in length.



Figure 7 - Immersion heater (Daraz, 2018)

Heating element 2 (heating rod)

This heating rod is also available on the Nepali market for 600NPR (€4.91). It has a wattage of 150W. A test was conducted to for the maximum temperature. This can be found in appendix pg.14 The maximum temperature for this heating element is more than 110°C. This heating element is 150mm in length with a diameter of 12mm.



Figure 8 - Heating rod

Availability

For the fluid warmer to be implemented in Nepal, both mentioned heating element could work. However, if this fluid warmer was to be implemented in other countries, these heating elements might not be available.

5.7.4 Conclusion

There are several heating elements available on the Nepali market. They may not be available in other countries.

Wish:

- Interchangeable heating element

5.8 Sub question 6 – How can the fluid warmer be made?

5.8.1 Production technique

FDM 3D-printing

The production technique for manufacturing the fluid warmer is 3D-printing. Field Ready has chosen this technique as their main manufacturing technique because of its deploy ability and versatility. FDM 3D printing is most commonly used and widely available in Nepal. The main benefits of 3D-printing the fluid warmer are:

- Easily open source
- Low initial cost
- Low investment cost
- Low replacement cost
- Allows fluid warmer to be modular
- Allows easy customization/branding
- Can be produced anywhere in the world

The negatives of 3D-printing the fluid warmer are:

- Lower durability
- Hospitals needs to own a 3D-printer or Field Ready needs to print the fluid warmer for them
- A hospital employee with 3D-printing experience is needed to produce the fluid warmer
- Post production surface finishing may be needed to make the fluid warmer usable in a hospital environment
- Maximum dimensions of parts are 25.5cmx20.5cmx20.5cm.

5.8.2 Materials

Casing

There are two different material filaments widely available in Nepal, ABS and PLA. Both filaments are priced the same at 4200NPR9 (€34.34) per KG.

ABS

Benefits:

- Stronger than PLA
- Higher melting point than PLA
- Can be treated with acetone to provide smooth, cleanable surface
- More durable than PLA

Negatives:

- Higher chance of warping during print

PLA

Benefits:

- PLA is biodegradable
- Easier to print
- No toxic fumes while printing
- Prints have a smoother finish
- Can be treated with epoxy for a smooth, cleanable surface

Negatives:

- Lower melting point than ABS
- PLA becomes pliable at 60°C

Insulation

Insulation may be needed to prevent the outside from the fluid warmer from becoming too warm and to keep the temperature around the IV-line up.

Styrofoam

Benefits:

- Easily available
- Cheap

Negatives:

- Will soften at 100°C

PE foam

Benefits:

- Cheap
- Available in Nepal

Negatives:

- Low melting point at 80°C

Floor foam

This foam is sold in Nepal in most stores.

Benefits:

- Easily available
- Very cheap

Negative:

- Low melting point

Fluid path

The fluid path is the area of the fluid warmer in which the IV line is placed. This area is crucial for heating the fluid. This path will be heated by the heating element and must conduct heat well.

Copper

Benefits:

- High thermal conductivity
- Available in Nepal
- Relatively cheap

Negatives:

- Not easy to find in sheet form

Aluminium

Benefits:

- High thermal conductivity
- Cheaper than copper
- Lighter than copper
- Available in Nepal

Negatives:

- Thermal conductivity not as high as copper

Silver

Benefits:

- Very high thermal conductivity

Negatives:

- Expensive
- Not easily available in Nepal

5.8.3 Conclusion

Field ready has 3D printing as its main production technique. Both ABS and PLA filament are 4200NPR. ABS has a higher melting point.

Although easily available in Nepal, most foams have low melting point.

Wish:

- Parts of the fluid warmer to be 3D-printed

6. Requirements

The following requirements are from the research in chapter 5 and standard specifications. To bring the fluid warmer onto the international market it needs to comply with all the requirements from the Standard Specification for Blood/Intravenous Fluid/Irrigation Fluid Warmers F2172-02 (Reapproved 2011).

Requirements from the standard specification and their tests are direct quotes from the Standard Specification for Blood/Intravenous Fluid/Irrigation Fluid Warmers F2172-02.

This list does also include wishes. These are good to add, but not necessary for the success of the fluid warmer.

Requirements	Test	Source
The Field Ready fluid warmer must be able to heat water and blood to from 1°C to 37°C at a flow rate of 6000 ml/h (100 ml/min).	Calculations. Cool water to 1°C and have this run through the fluid warmer in an IV line. Measure the output temperature.	Research 5.3 Research 5.5 Research 5.6
All parts needed to produce the fluid warmer must cost less than \$75 in total.	Cost calculations.	Research 5.4
The field ready fluid warmer must be ready for use (35.2°C) in 189 seconds or less.	Calculations.	Research 5.4
The Field Ready fluid warmer must be able to be acquired and produced in Nepal.	Producing a prototype.	Research 5.4
The maximum temperature the fluid can be heated to must not exceed 42°C.	Test with electronics.	Research 5.5
The fluid warmer warms blood via the heating technique "dry heat".	Compliance is checked by inspection.	Research 5.5
Doctors and nurses must be able to use the fluid warmer after a 15 minute instruction.	Hands on verification in ANI.	Research 5.5
The fluid warmer must be open source.	Compliance is checked by inspection.	Research 5.4
Easily cleanable surface.	Compliance is checked by inspection.	Research 5.6
The fluid warmer has no direct contact with fluids.	Compliance is checked by functional test.	Research 5.6
Wish	Test	Source
Part of the fluid warmer can be 3D-printed	Compliance is checked by inspection.	Research 5.8
The fluid warmer has an interchangeable heating element	Compliance is checked by inspection.	Research 5.7
The fluid warmer can work on different power sources	Compliance is checked by inspection.	Research 5.6

Requirements	Test	Source
<p>Equipment or equipment parts shall be marked as follows:</p> <ul style="list-style-type: none"> - Where appropriate: to warn against possible safety hazards from penetration by sharp objects - To specify, in the case of equipment parts supplied or controlled by an external sensing device, that the equipment shall only be used with the external sensing device specified by the manufacturer of the equipment 	Compliance is checked by inspection.	Standard specifications
Fluid warmers shall display set point temperature (The temperature, which may be operator adjustable, used by the fluid warmer as the desired temperature of the blood, intravenous solution or irrigation fluid, upon operator demand.) Fluid warmers with a fixed set point temperature shall be labelled with that value.	Compliance is checked by inspection.	Standard specifications
There shall be a visual temperature indicator capable of displaying the active controlled temperature (the temperature displayed by the fluid warmer and derived from a sensor in the fluid warmer).	Compliance is checked by inspection.	Standard specifications
Minimum resolution of the visual temperature indicator shall be 2 degrees C.	Compliance is checked by inspection.	Standard specifications
The visual temperature indicator shall have an accuracy of 2 degrees C or better.	Compliance is checked by inspection.	Standard specifications
Means for drainage of fluid leaking from the equipment shall be provided.	Compliance is checked by inspection.	Standard specifications

Requirements	Test	Source
<p>The fluid path (the channel through which the product intended for patient infusion or irrigation flows in-line (through a closed pathway) from its source (e.g., blood bag, intravenous solution bag, or irrigation fluid bag) to the patient) shall withstand 375mm Hg pressure or 1.25 times the manufacturer maximum recommended pressure, whichever is greater.</p>	<p>The fluid path is primed with water according to manufacturer's instructions and the set point temperature is set to its maximum value. With the output clamped, pressurize the fluid path to 377mm Hg pressure or 1.25 times the recommended pressure, whichever is greater and maintain for two minutes. The fluid path shall not leak.</p>	<p>Standard specification</p>
<p>The fluid warmer shall not cause thermal haemolysis at levels that constitute a safety hazard.</p>	<p>Water at a temperature of 10 degrees C (- 2) is passed through the system and the fluid temperature at the warmest location within the FLUID PATH is measured. A minimum of three flow rates are required to be tested: maximum flow rate (per manufacturer's specification) of the device, mid-range flow rate, and minimum flow rate no greater than 100ml/hour. Test shall be run until steady state is achieved or up to a maximum time of fifteen minutes. The time/temperature combinations of the water for each half-degree increment beginning with 46 degrees C shall remain below the values shown in appendix pg.15.</p> <p>From each of the three flow rates, clamp the output (stop flow). Monitor the temperature until the value stays below 46 degrees. The time/temperature combinations of the water for each half-degree increment beginning with 46 degrees shall remain below the values shown in appendix pg.16.</p> <p>For any time-temperatures combinations above the values shown in Figure 101 an accepted alternate test method to show compliance is to measure haemolysis under the same test conditions.</p>	<p>Standard specification</p>
<p>The effectiveness of the independent thermal cut-out shall not be affected by any change or fault in the control thermostat and its associated system.</p>	<p>Compliance is checked by inspection.</p>	<p>Standard specification</p>

Requirements	Test	Source
There shall be an auditory and visual alarm when either the thermal cut-out or the self-resetting thermal cut-out operates.	Compliance is checked by a functional test.	Standard specification
In the event that the fluid warmer is switched off after the thermal cut-out has operated, and is then switched on again before the fault condition has been corrected, both auditory and visual indicators shall operate immediately.	Compliance is checked by a functional test.	Standard specification
It shall not be possible for the operator to silence the auditory alarm for more than two minutes.	Compliance is checked by functional tests	Standard specification
It shall not be possible for the operator to cancel any visual alarm while the alarm condition exists.	Compliance is checked by functional tests	Standard specification
The auditory and visual alarm systems shall either be automatically self-testing at switch-on, or there shall be a manual test facility.	Compliance is checked by performing the test method contained in the instructions for use. Test method is required in the accompanying document.	Standard specification
A distinct visual indicator shall be required for each alarm where immediate operator response is indicated. Auditory alarms may be combined.	Compliance is checked by inspection and operation of the equipment.	Standard specification
Means must be provided for the user to confirm that the thermal cut-out is operational.	Compliance is checked by performing the test method contained in the instructions for use. Test method is required in the accompanying document.	Standard specification
Plugs and socket-outlets, and other connecting devices on flexible cords, used for an intermediate connection between different parts of a fluid warmer, shall not be interchangeable with plugs and socket outlets complying with IEC 83, or with connectors and appliance inlets complying with the standard sheets of IEC 320, if connection of these parts to the supply mains could cause a safety hazard.	Compliance is checked by inspection and by manual test.	Standard specification

Requirements from standard specifications	Test	Source
The fluid warmer shall not create output fluid temperatures (the temperature of the fluid at the exit of the fluid path) that cause thermal injury.	Water is passed through the system and the output fluid temperature is measured. Single fault condition(s) are applied under least favourable conditions. The output fluid temperature is measured. The time/temperature combinations of the water for each half-degree increment beginning with 45 degrees C shall remain below the values shown in appendix pg.17.	Standard specification
In addition to the control thermostat, an independent thermal cut-out shall be provided and set to operate so that a safety hazard (haemolysis and/or patient thermal injury) does not occur.	Compliance is checked by inspection.	Standard specification
A remote sensor may be used to control the heating, but such sensors shall not be used to control the maximum temperature that the fluid warmer can attain. That maximum temperature shall be controlled only as a result of measurements made by a sensor or sensors appropriately positioned in the fluid warmer.	Compliance is checked by inspection.	Standard specification
The fluid warmer must be still be able to work normally after spillage on de surface of the fluid warmer.	The equipment is positioned as in normal use. 200ml of isotonic saline (0.9g sodium chloride per litre of water) is poured steadily on an arbitrary point on the top surface of the equipment, for approximately 15 seconds, from a height not exceeding 5 cm. After the test, the equipment shall comply with all the requirements of this Standard for normal use.	Standard specifications

Requirements	Test	Source
<p>There must be an accompanying document containing instructions including the following:</p> <ul style="list-style-type: none"> - A recommendation that the equipment or equipment parts be checked for mechanical damage prior to each use. - If applicable, statements, details and warnings on the use of the fluid warmer in combination with other heat sources (i.e. preheated fluid bags). - Particulars of any necessary calibration procedure to be performed by the operator or user. - Information as to how to test an alarm system if the alarm system is not tested automatically when the equipment is switched on. - Information as to how the operator can confirm that the independent thermal cut-out (a safety device that interrupts electric current when the heater is heated to a certain degree) is functioning correctly. - If the fluid warmer contains a mains failure alarm, a statement to that effect. - Specify that perforation of the applied part containing an electrical component (e.g., heating element, wire, temperature sensor) is a single fault condition and not to be used. 	<p>Compliance is checked by inspection</p>	<p>Standard specifications</p>

7. Design

7.1 Introduction

The following chapter will include calculations, sketches, 3D-CAD models, prototypes and more. The subproblems will result in multiple viable options as a solution. While designing the casing the best solution for that specific design will be chosen from these options.

7.2 Main and subproblems

The main problem is the casing. To design the casing multiple subproblems need to be resolved first:

- How hot would the fluid warmer need to be to heat the fluids to 37°C in 25 cm?
- IV-line layout
- Electronics
- IV pole connection

The casing will be designed followed by the assembly of the casing.

7.3 Subproblem 1: How hot would the fluid warmer need to be to heat the fluids to 37°C in 25 cm?

7.3.1 Introduction

The fluids need to be warmed to 37°C. These calculation shows how long it will take to heat the different fluids with a heating element at 37°C, and how many cm of IV line is needed to heat the fluids to this temperature. The two fluids that are most commonly used are saline and whole blood

7.3.2 Formulas

Formulas needed to calculate this are:

$$\dot{Q} = \frac{T_1 - T_2}{R}$$

$$\Delta T_2 = \frac{\dot{Q} \cdot \Delta t}{C_p}$$

$$R = \frac{l}{kA}$$

$$C_p = c_p \cdot m$$

$$m = A \cdot l \cdot \rho_{blood}$$

$$T_{2New} = T_{2Previous} + \Delta T_2$$

$$A = \left(\frac{d}{2}\right)^2 \pi$$

$$v = \frac{\dot{V}}{A}$$

\dot{Q} = Heat transfer rate in W (watt)

T_1 = Outside temperature (temperature of the heater) = 37°C

T_2 = Inside temperature (temperature of blood before heating) = 1°C

R = Thermal resistance K/W (kelvin/ watt)

Cp = Heat capacity in J/K (joule/kelvin)

l = length in m= 0.001 m

k = Thermal conductivity of blood in W/mK (watt/meter kelvin)= 0.52 W/mK (IT IS Foundation, 2017).

cp = specific heat of blood in J/kgK (joule/kilogram kelvin) = 3594 J/kgK (Blake, Petley, & Deakin, 2000)

A = Area of heat conduction

m = mass in kg (kilogram)

d = Diameter in mm = 2.5 mm

Δ = Increment

t = time in s (second)

ρ = density of blood kg/m³ (kilogram /cubic meter)= 1060 kg/m³ (Shmukler, 2017)

7.3.3 Calculations

Appendix pg.20 shows the calculations made with the heating element at 37°C.

The temperature of the blood is 35.4°C after 21 seconds.

When the temperature of the heating element is 37°C, it will take 21 seconds to heat the blood to an acceptable temperature.

At a flow rate of 100ml/min each second equals 34.6cm of IV line needed to heat the blood.

$$34.6 \cdot 21 = 727\text{cm}$$

Table 3 shows how much IV line is needed at each temperature calculated.

727 cm is not an acceptable number.

Seconds	Cm of IV line at flowrate 100ml/min	°C of the blood with the heating element at 37°C
0	0	1
1	35	5.9
2	69	10.2
3	104	13.8
4	138	17.0
5	173	19.7
6	208	22.1
7	242	24.1
8	277	25.9
9	311	27.4
10	346	28.7
11	381	29.8
12	415	30.8
13	450	31.7
14	484	32.4
15	519	33.0
16	554	33.6
17	588	34.0
18	623	34.4
19	657	34.7
20	692	35.1
21	727	35.4

Table 3 - CM of IV line needed at a flowrate of 100ml/min with the heating element at 37°C

The maximum allowable temperature of the blood is 42°C. To cut down on heating time the heating element will be turned up to 42°C while the output still has a maximum of 37°C. This can be calculated with the same formulas, changing T_1 from 37°C to 42°C.

The temperature of the blood is 36.7°C after 14 seconds.

When the temperature of the heating element is 42°C, it will take 14 seconds to heat the blood to an acceptable temperature.

Table 4 shows that at a flow rate of 100ml/min, it would still take 484 cm of IV line to heat the blood to an acceptable temperature. This is not an acceptable number.

Seconds	Cm of IV line at flowrate 100ml/min	°C of the blood with the heating element at 42°C
0	0	1
1	35	6.6
2	69	11.6
3	104	15.2
4	138	18.9
5	173	22.0
6	208	24.8
7	242	27.1
8	277	29.1
9	311	30.9
10	346	32.4
11	381	33.7
12	415	34.9
13	450	35.9
14	484	36.7

Table 4 - CM of IV line needed at a flowrate of 100ml/min with the heating element at 42°C

Seconds	Cm of IV line needed at flowrate 100ml/min = 6000ml/h	Cm of IV line needed at flowrate 50ml/min = 3000ml/h	Cm of IV line at needed flowrate 25ml/min = 1500ml/h	Cm of IV line needed at flowrate 20ml/min = 1200ml/h	Cm of IV line needed at flowrate 15ml/min = 900ml/h	Cm of IV line needed at flowrate 10ml/min = 600ml/h	Cm of IV line needed at flowrate 8.5ml/min = 510ml/h	°C of the blood with the heating element at 42°C
0	0	0	0	0	0	0	0	1
0.5	17	8	4.25	3.4	2.55	1.75	1.45	
1	X	17	8.5	6.8	5.1	3.5	2.9	6.6
1.5	X	25.5	12.75	10.2	7.65	5.25	4.35	
2	X	X	17	13.6	10.2	7	5.8	11.6
2.5	X	X	21.25	17	12.75	8.75	7.25	
3	X	X	25.5	20.4	15.3	10.5	8.7	15.2
3.5	X	X	X	23.8	17.85	12.25	10.15	
4	X	X	X	X	20.4	14	11.6	18.7
4.5	X	X	X	X	22.95	15.75	13.05	
5	X	X	X	X	25.5	17.5	14.5	22.0
5.5	X	X	X	X	X	19.25	15.95	
6	X	X	X	X	X	21	17.4	24.8
6.5	X	X	X	X	X	22.75	18.85	
7	X	X	X	X	X	24.5	20.3	27.1
7.5	X	X	X	X	X	X	21.75	
8	X	X	X	X	X	X	23.2	29.1
8.5	X	X	X	X	X	X	24.65	
9	X	X	X	X	X	X	X	30.9

Table 5 – Cm of IV line needed at different flowrates with the heating element at 42°C

The last variable is the flowrate. Table 5 shows the cm of IV line needed to heat the blood at different flowrates. The cm of IV line is calculated in appendix pg.25.

The IV tube can only be inside of the fluid warmer for a maximum of 25 cm (Er Kishor Bhandari, 20-11-2017, LOG, appendix p.4). The yellow numbers in table 5 show that the blood, even at the slowest flowrate will still only heat up to 28.3°C. The heating element needs to be hotter to be able to heat the blood to an acceptable temperature.

Table 6 is calculated with the heating element at 50°C. Calculations can be found in appendix pg.28.

It shows that with the heating element at 50°C it is possible to heat the blood to an acceptable temperature with a flowrate of 8.5 ml/min.

Seconds	Cm of IV line needed at flowrate 100ml/min = 6000ml/h	Cm of Iv line needed at flowrate 50ml/min = 3000ml/h	Cm of Iv line at needed flowrate 25ml/min = 1500ml/h	Cm of Iv line needed at flowrate 20ml/min = 1200ml/h	Cm of Iv line needed at flowrate 15ml/min = 900ml/h	Cm of Iv line needed at flowrate 10ml/min = 600ml/h	Cm of Iv line needed at flowrate 8.5ml/min = 510ml/h	°C of the blood with the heating element at 50°C
0	0	0	0	0	0	0	0	1
0.5	17	8	4.25	3.4	2.55	1.75	1.45	
1	X	17	8.5	6.8	5.1	3.5	2.9	7.7
1.5	X	25.5	12.75	10.2	7.65	5.25	4.35	
2	X	X	17	13.6	10.2	7	5.8	13.5
2.5	X	X	21.25	17	12.75	8.75	7.25	
3	X	X	25.5	20.4	15.3	10.5	8.7	18.5
3.5	X	X	X	23.8	17.85	12.25	10.15	
4	X	X	X	X	20.4	14	11.6	22.8
4.5	X	X	X	X	22.95	15.75	13.05	
5	X	X	X	X	25.5	17.5	14.5	26.5
5.5	X	X	X	X	X	19.25	15.95	
6	X	X	X	X	X	21	17.4	29.7
6.5	X	X	X	X	X	22.75	18.85	
7	X	X	X	X	X	24.5	20.3	32.5
7.5	X	X	X	X	X	X	21.75	
8	X	X	X	X	X	X	23.2	34.9
8.5	X	X	X	X	X	X	24.65	
	X	X	X	X	X	X	X	36.9

Table 6 - CM of IV line needed at different flowrates with the heating element at 50°C

Table 7 is calculated with the heating element at 60°C. Calculations can be found in appendix pg.31.

With the heating element at 60°C it is possible to heat the blood to an acceptable temperature with a flowrate of 10 ml/min.

Seconds	Cm of IV line needed at flowrate 100ml/min = 6000ml/h	Cm of Iv line needed at flowrate 50ml/min = 3000ml/h	Cm of Iv line at needed flowrate 25ml/min = 1500ml/h	Cm of Iv line needed at flowrate 20ml/min = 1200ml/h	Cm of Iv line needed at flowrate 15ml/min = 900ml/h	Cm of Iv line needed at flowrate 10ml/min = 600ml/h	Cm of Iv line needed at flowrate 8.5ml/min = 510ml/h	°C of the blood with the heating element at 60°C
0	0	0	0	0	0	0	0	1
0.5	17	8	4.25	3.4	2.55	1.75	1.45	
1	X	17	8.5	6.8	5.1	3.5	2.9	9.1
1.5	X	25.5	12.75	10.2	7.65	5.25	4.35	
2	X	X	17	13.6	10.2	7	5.8	16.0
2.5	X	X	21.25	17	12.75	8.75	7.25	
3	X	X	25.5	20.4	15.3	10.5	8.7	22.0
3.5	X	X	X	23.8	17.85	12.25	10.15	
4	X	X	X	X	20.4	14	11.6	27.2
4.5	X	X	X	X	22.95	15.75	13.05	
5	X	X	X	X	25.5	17.5	14.5	31.6
5.5	X	X	X	X	X	19.25	15.95	
6	X	X	X	X	X	21	17.4	35.5
6.5	X	X	X	X	X	22.75	18.85	

Table 7 - CM of IV line needed at different flowrates with the heating element at 60°C

Table 8 is calculated with the heating element at 70°C. Calculations can be found in appendix pg.33.

With the heating element at 70°C it is possible to heat the blood to an acceptable temperature with a flowrate of 15 ml/min.

Seconds	Cm of IV line needed at flowrate 100ml/min = 6000ml/h	Cm of Iv line needed at flowrate 50ml/min = 3000ml/h	Cm of Iv line at needed flowrate 25ml/min = 1500ml/h	Cm of Iv line needed at flowrate 20ml/min = 1200ml/h	Cm of Iv line needed at flowrate 15ml/min = 900ml/h	Cm of Iv line needed at flowrate 10ml/min = 600ml/h	Cm of Iv line needed at flowrate 8.5ml/min = 510ml/h	°C of the blood with the heating element at 70°C
0	0	0	0	0	0	0	0	1
0.5	17	8	4.25	3.4	2.55	1.75	1.45	
1	X	17	8.5	6.8	5.1	3.5	2.9	10.4
1.5	X	25.5	12.75	10.2	7.65	5.25	4.35	
2	X	X	17	13.6	10.2	7	5.8	18.6
2.5	X	X	21.25	17	12.75	8.75	7.25	
3	X	X	25.5	20.4	15.3	10.5	8.7	25.6
3.5	X	X	X	23.8	17.85	12.25	10.15	
4	X	X	X	X	20.4	14	11.6	31.6
4.5	X	X	X	X	22.95	15.75	13.05	
5	X	X	X	X	25.5	17.5	14.5	36.8

Table 8 - CM of IV line needed at different flowrates with the heating element at 70°C

Table 9 is calculated with the heating element at 80°C. Calculations can be found in appendix pg.35.

With the heating element at 80°C it is possible to heat the blood to an acceptable temperature with a flowrate of 15 ml/min.

These calculations were also done for the heating element at 90°C. The calculations can be found in appendix pg.37.

After consultation with the Field Ready Nepal team (27-11-2017, LOG, appendix pg.4), it was decided that 80°C is the maximum temperature for the heating element, because of risk of overheating.

Seconds	Cm of IV line needed at flowrate 100ml/min = 6000ml/h	Cm of Iv line needed at flowrate 50ml/min = 3000ml/h	Cm of Iv line at needed flowrate 25ml/min = 1500ml/h	Cm of Iv line needed at flowrate 20ml/min = 1200ml/h	Cm of Iv line needed at flowrate 15ml/min = 900ml/h	Cm of Iv line needed at flowrate 10ml/min = 600ml/h	Cm of Iv line needed at flowrate 8.5ml/min = 510ml/h	°C of the blood with the heating element at 80°C
0	0	0	0	0	0	0	0	1
0.5	17	8	4.25	3.4	2.55	1.75	1.45	
1	X	17	8.5	6.8	5.1	3.5	2.9	11.8
1.5	X	25.5	12.75	10.2	7.65	5.25	4.35	
2	X	X	17	13.6	10.2	7	5.8	21.1
2.5	X	X	21.25	17	12.75	8.75	7.25	
3	X	X	25.5	20.4	15.3	10.5	8.7	29.1
3.5	X	X	X	23.8	17.85	12.25	10.15	
4	X	X	X	X	20.4	14	11.6	36.1

Table 9 - CM of IV line needed at different flowrates with the heating element at 80°C

7.3.4 Conclusion

Table 10 shows the advised temperature of the heating element at different flowrates, and what the output temperature of the blood will be.

Because the temperature of the heating element is hotter than the temperature that the blood can maximally get, there needs to be an extra sensor monitoring the output temperature of the blood. This is to prevent the blood from overheating, especially with different flowrates. The sensor can't be in contact with the blood, so a test needs to be done comparing the outside temperature of the IV line with the temperature of the blood (during testing this will be water).

The fluid warmer will not be able to meet the requirement of warming the blood to 37°C at a flowrate of 100ml/min with the heating element at 80 °C.

All the calculations have been checked by Kieran Ram, design associate at Field Ready who has a degree in mechanical engineering.

These calculations do not account for the drag of the fluid at the sides of the tube and the temperature difference this created within the fluid. This could affect the reading of the second temperature sensor.

These calculations are an estimate. The actual temperature of the blood could differ due to a different the temperature in the room, humidity, different starting temperature and other variables. This needs to be taken in account when seeing these temperatures.

Seconds	Flowrate	Cm of IV line	Advised temperature Of heating element	Temperature of blood
0.75	100 ml/min	25	80°C	9.1°C
1.5	50 ml/min	25.5	80°C	16.5°C
3	25 ml/min	25.5	80°C	27.7°C
3.5	20 ml/min	23.8	80°C	32.6°C
5	15 ml/min	25.5	70°C	35.1°C
7	10 ml/min	24.5	60°C	37.3°C
8.5	8.5 ml/min	24.65	50°C	35.8°C

Table 10 - Advised temperature of the heating element at different flowrates

7.4 Subproblem 2: IV Line layout

7.4.1 Introduction

The layout of the IV line is the way the IV line will go through the fluid warmer. It is important that the layout does not interfere with the flowrate.

7.4.2 Heating element

Introduction

The IV line can be wrapped around the heating element. This will eliminate the need for an extra part.

Solution 1

Sketches

Figures 9 and 10 show sketches from a brainstorm about his solution

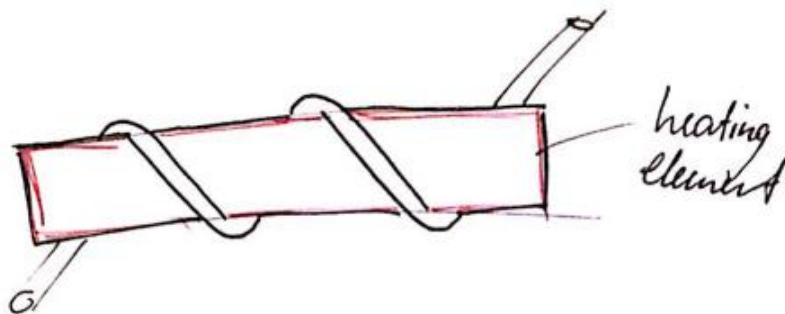

Figure 9 - Sketch from brainstorm

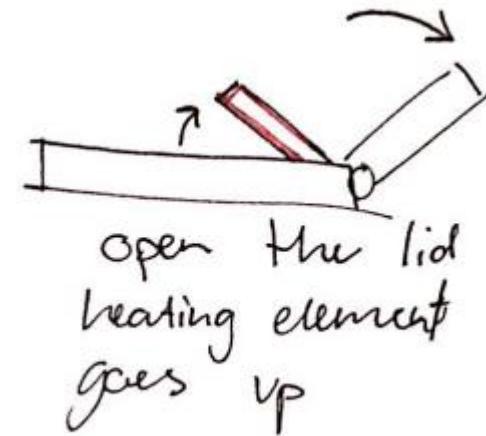

Figure 10 - Sketch 2 from brainstorm

Feedback

Kieran Ram gave the following feedback when asked about this solution: "With the heating element sticking out of the fluid warmer and an hospital employee physically needing to wrap the IV line around it I think the chances of burns are really big. I don't think this method would be appropriate for the fluid warmer, it doesn't seem intuitive."

Conclusion

This method is not easy in use due to high chances of burns. A different solution will be needed.

7.4.3 Metal plate

Introduction

Using a metal plate to disperse the heat of the heating element a larger surface area is created for the IV line to sit on.

Solution 1

Sketches

Figure 11 shows sketches from a brainstorm about this solution. This solution was chosen from a bigger brainstorm about heating the IV line. These options can be found in appendix pg.38.

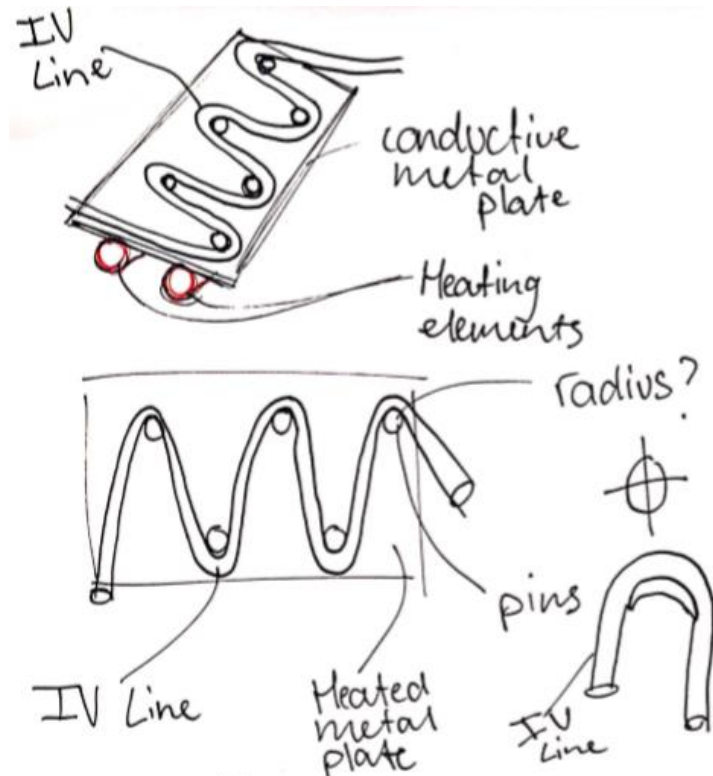

Figure 11 - Sketches solution 1 brainstorm

Prototype & test

A piece of cardboard was used to test different radiuses for the bends; 3, 4 and 5 mm. This is shown in figure 12.



Figure 12 - Solution 1 test

Conclusion

All the different radiuses used in the test have the IV-line fold over on itself, compromising the flow. The radius of the bends needs to be bigger to prevent this.

Solution 2

By using clamps instead of pins, the IV line can be held in place without the line bending over on itself.

Prototype and test

Figure 13 shows a metal prototype of the clamp. Figure 14 shows a cardboard prototype that proves the IV line can be lead through these clamps without bending.

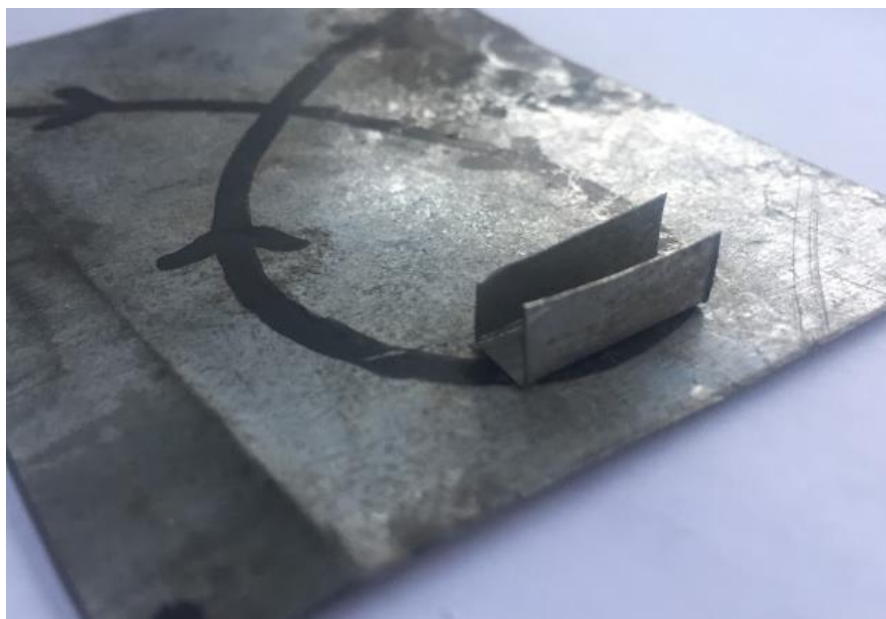

Figure 13 - Metal prototype of the fluid path

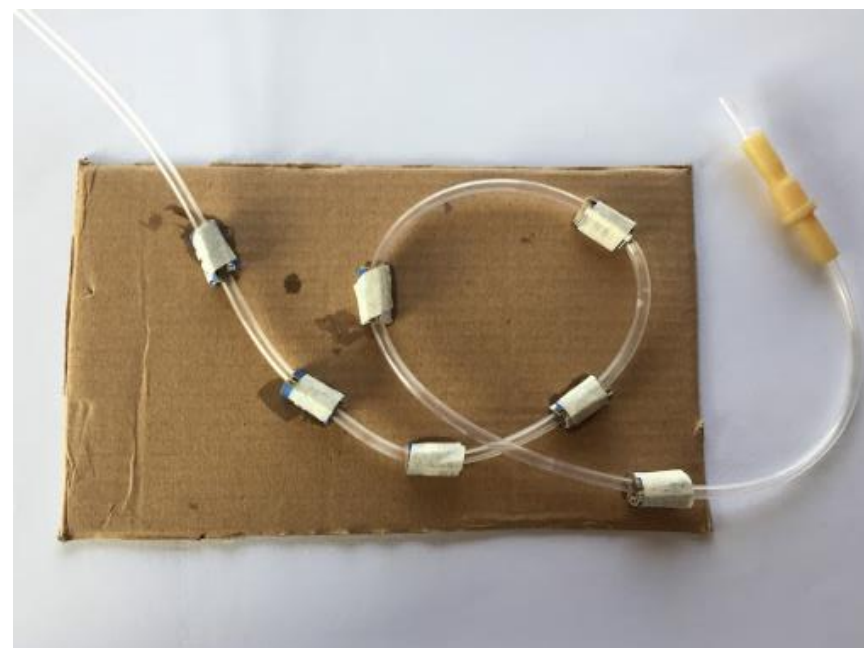

Figure 14 - Cardboard prototype

Conclusion

These clamps can lead the IV line through the fluid warmer without it bending, as long as the positioning of the clamps isn't too close together. The IV line in the cardboard prototype is longer than 25cm, there needs to be a different solution with the same clamps.

Solution 2.1

By having the IV tube go in and out of the fluid warmer on the same side, the room the metal plate will take up will be minimised.

Prototype and test

Figure 15 shows the path of the IV line and figure 16 shows how the IV line behaves on this track.

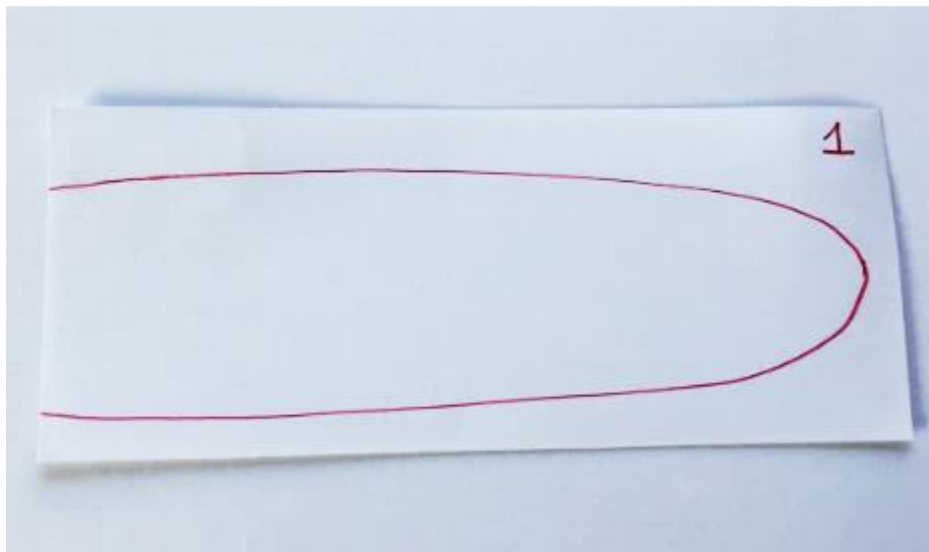

Figure 15 - Path of the IV line of solution 2.1

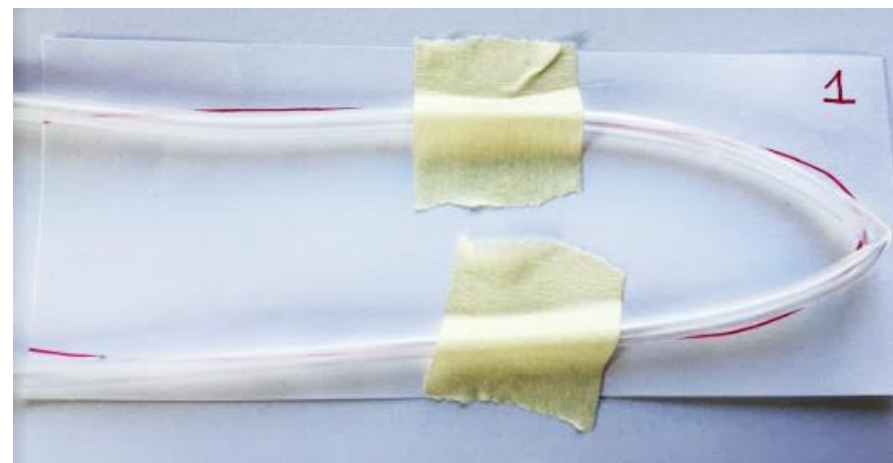

Figure 16 - IV line on the path of solution 2.1

Conclusion

The IV line in figure 16 kinks and this solution won't be usable in the fluid warmer. If the bend is wider, it might be usable.

Solution 2.2

Solution 2.2 is a variation on solution 2.1, to widen the bend to prevent the IV line from bending and closing itself.

Prototype and test

Figure 17 shows the path of the IV line and figure 18 shows how the IV line behaves on this track.

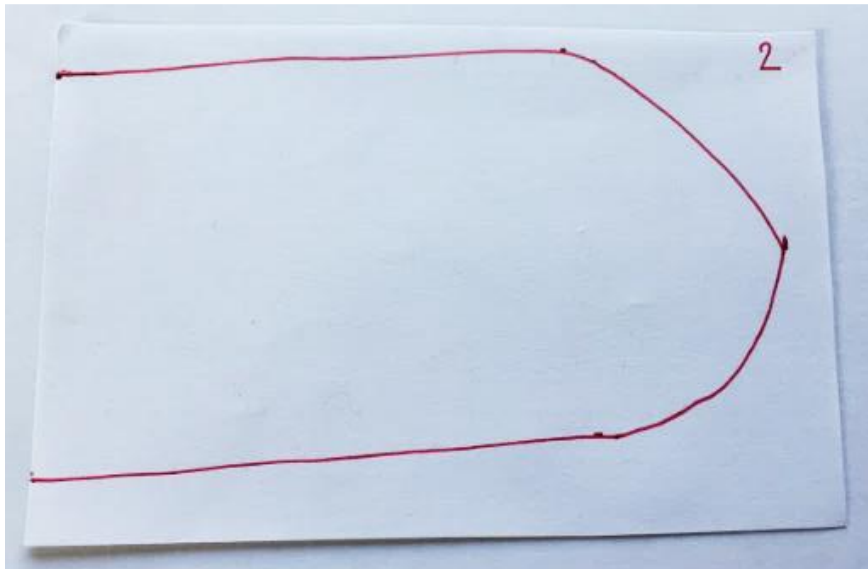

Figure 17 - Path of the IV line of solution 2.2

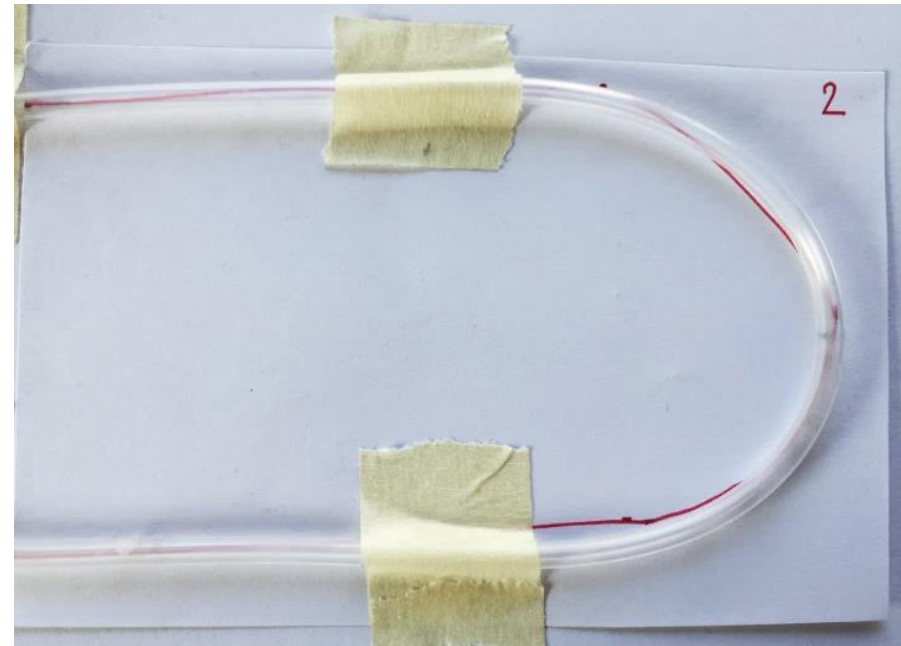

Figure 18 - IV line on the path of solution 2.2

Conclusion

The IV line in figure 18 goes around the bend without trouble. This is a suitable solution, but takes up a lot of room in the fluid warmer due to the wide bend.

Solution 2.3

Solution 2.3 has the IV line come out of the fluid warmer opposite the side the IV line went in. The extra bend decreases the width the fluid warmer needs to be.

Prototype and test

Figure 19 shows the path of the IV line and figure 20 shows how the IV line behaves on this track.

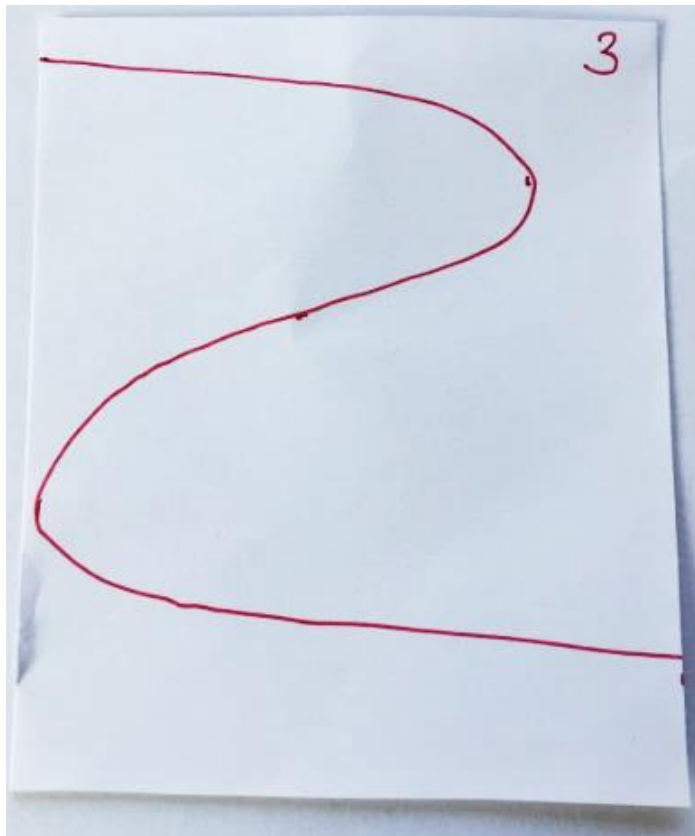

Figure 19 - Path of the IV line of solution 2.3

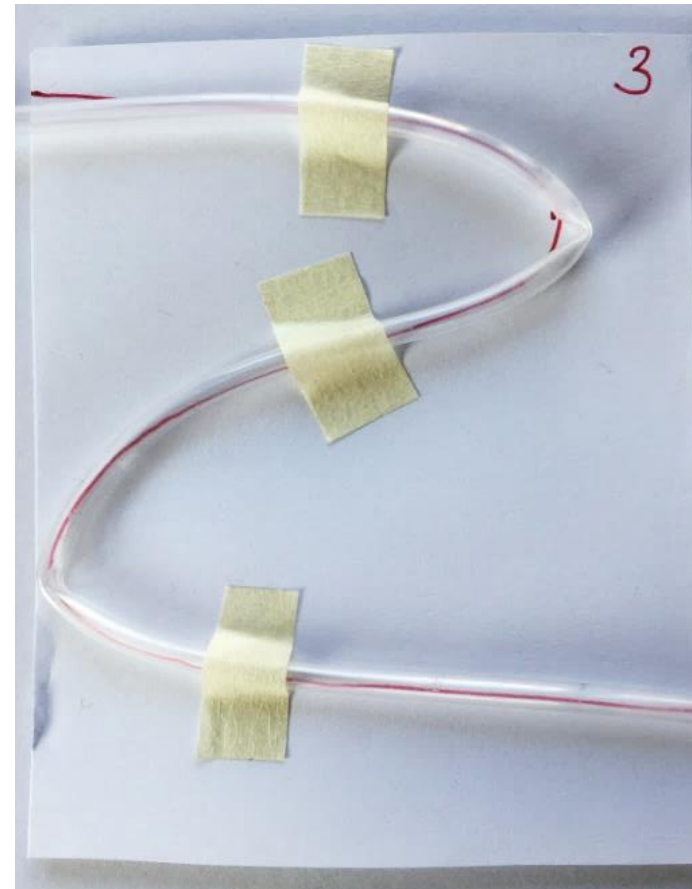

Figure 20 - IV line on the path of solution 2.3

Conclusion

Like with solution 1, the bends are too small causing the IV line to kink, disrupting flow. This solution is not suitable.

Solution 2.4

Solution 2.4 is a loop that will minimise the space the IV line takes up in the fluid warmer.

Prototype and test

Figure 21 shows the path of the IV line and figure 22 shows how the IV line behaves on this track.

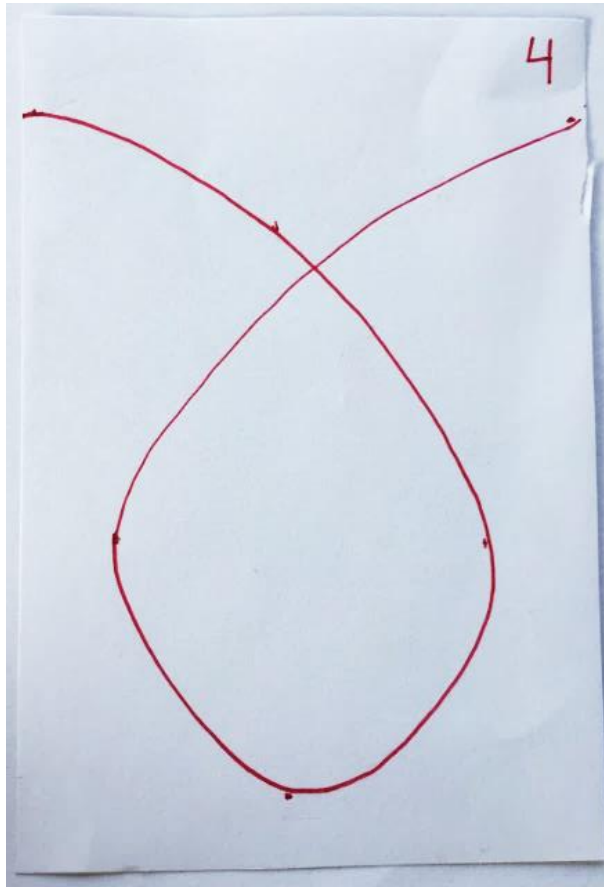

Figure 21 - Path of the IV line of solution 2.4

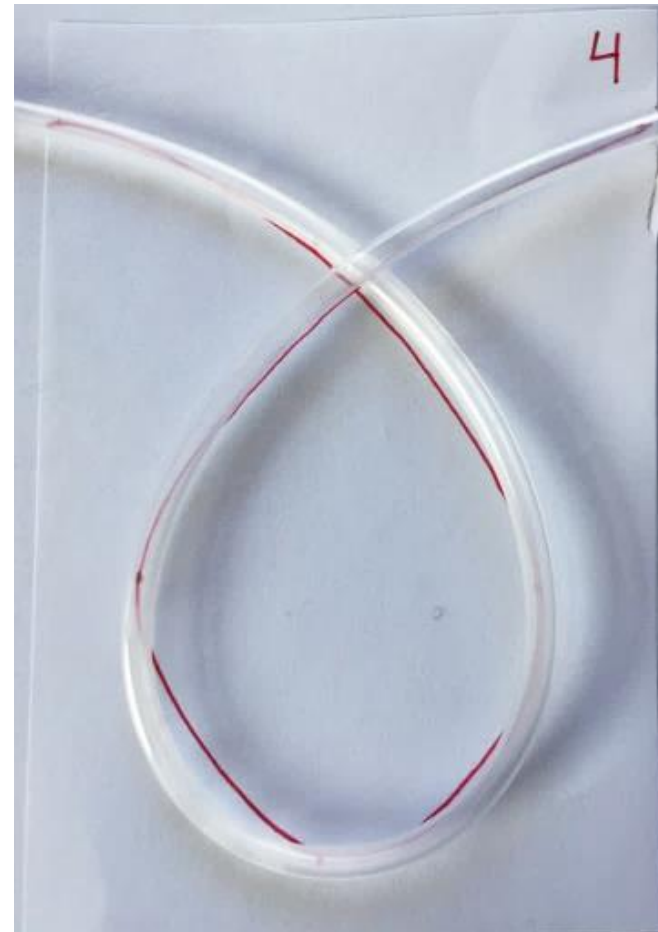

Figure 22 - IV line on the path of solution 2.4

Conclusion

The IV line can follow this path without trouble, and there is no need for clamps to hold the IV line in place apart from the place where the IV line enters and exits the fluid warmer. A question that needs to be answered in further testing is; will the loop disrupt the flow and/or flowrate?

Solution 2.5

Solution number 2.5 is a variation on the solution in 2.4, with the output lower than the input, which may improve the flow.

Prototype and test

Figure 23 shows the path of the IV line and figure 24 shows how the IV line behaves on this track.

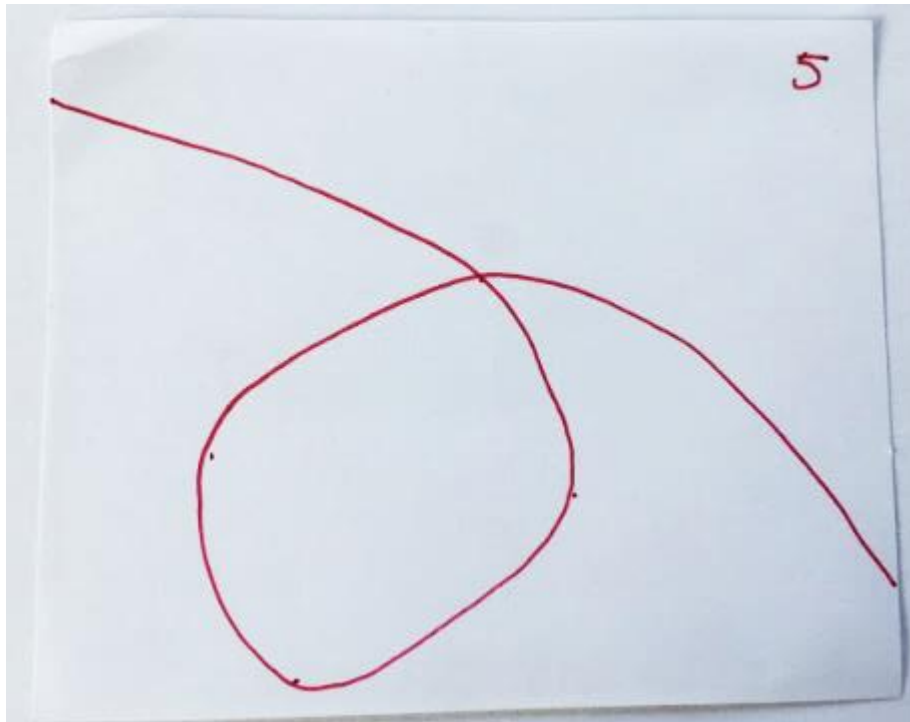

Figure 23 - Path of the IV line of solution 2.5

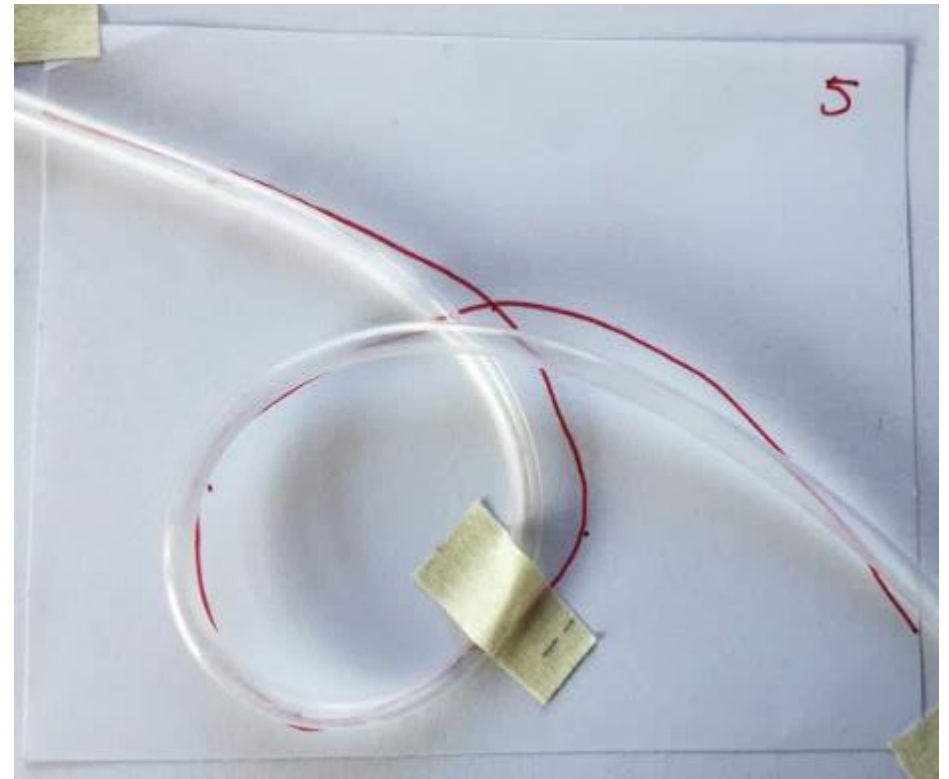

Figure 24 - IV line on the path of solution 2.5

Conclusion

The solution in 2.5 works the same way the solution in 2.4. Further testing with different variations of this design is needed to prove that the loop will not affect flow.

Test

The following test was executed to figure out if the path of the IV line influences the flowrate.

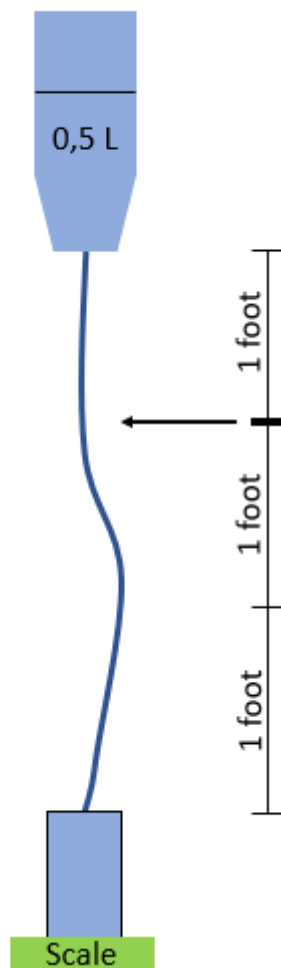

Figure 25 - Test setup

Materials:

- 0.5 litre of water
- 2 water bottles (1L)
- IV line with flow regulator
- Scale
- Stopwatch

Method:

Figure 25 shows the test setup.

0.5 litre of water will be added to the top bottle. The flow regulator will regulate the flow to be 2 different flowrates; 50 and 100 ml/min. A baseline will be established with each flowrate. Then different variations of solutions 2, 4 and 5 will be added at 2 feet. The flow will be timed to measure the difference between each solution and compare that to the baseline. If the difference is greater than 5% of the flowrate the solution is not usable because the flowrate will not be close enough to the flowrate the doctors prescribe for the patient. Photos of this setup can be found in appendix pg.39.

Solution 2 & 2.1

Figure 26 shows the variations of the solution, table 11 shows the results of the test performed with a flow rate of 100ml/min and table 12 shows the results of the test performed with a flowrate of 50ml/min.

Conclusion

Solution 2.1 goes over the maximum difference at 15% therefore, it influences the flow rate too much to be used. Solution 2 has passed the test and can be used.

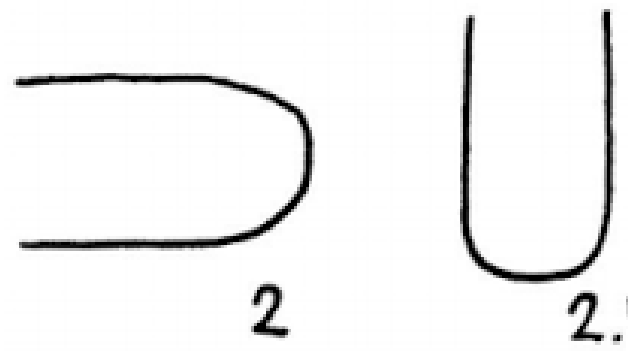

Figure 26 - Solution 2 & 2.1

Solution	Feet	MI/min 1	MI/min 2	MI/min 3	Average	Difference from baseline
Baseline	2	98	98	102	99	x
Solution 2	2	108	91	90	96	3 ml - 3%
Solution 2.1	2	87	85	80	84	15 ml - 15%

Table 11 - Solution 2&2.1 - 100 ml/min

Solution	Feet	MI/min 1	MI/min 2	MI/min 3	Average	Difference from baseline
Baseline	2	48	47	49	48	x
Solution 2	2	51	50	50	50.3	2.3 ml - 4.8%
Solution 2.1	2	48	43	46	45.6	2.4 ml - 5%

Table 12 - Solution 2&2.1 - 50 ml/min

Solution 4 & 4.1 & 4.2

Figure 27 shows the variations of the solution, table 13 shows the results of the test performed with a flow rate of 100ml/min and table 14 shows the results of the test performed with a flowrate of 50ml/min.

Conclusion

Solution 4, 4.1 and 4.2 all pass this test.



Figure 27 - Solution 4, 4.1 & 4.2

Solution	Feet	MI/min 1	MI/min 2	MI/min 3	Average	Difference from baseline
Baseline	2	98	101	100	99.7	x
Solution 4	2	101	100	100	100.3	0.6ml - 0.6%
Solution 4.1	2	98	100	99	99	0.7ml - 0.7%
Solution 4.2	2	99	98	99	98.7	1ml - 1%

Table 13 - Solution 4, 4.1 & 4.2 - 100ml/min

Solution	Feet	MI/min 1	MI/min 2	MI/min 3	Average	Difference from baseline
Baseline	2	51	50	51	50.7	x
Solution 4	2	50	49	49	49.3	2.8%
Solution 4.1	2	50	49	50	49.6	2.0%
Solution 4.2	2	51	50	50	50.3	0.8%

Table 14 - Solution 4, 4.1 & 4.2 - 50ml/min

Solution 5 & 5.1 & 5.2

Figure 28 shows the variations of the solution, table 15 shows the results of the test performed with a flow rate of 100ml/min and table 16 shows the results of the test performed with a flowrate of 50ml/min.

Conclusion

Both solution 5 and 5.1 pass the test.

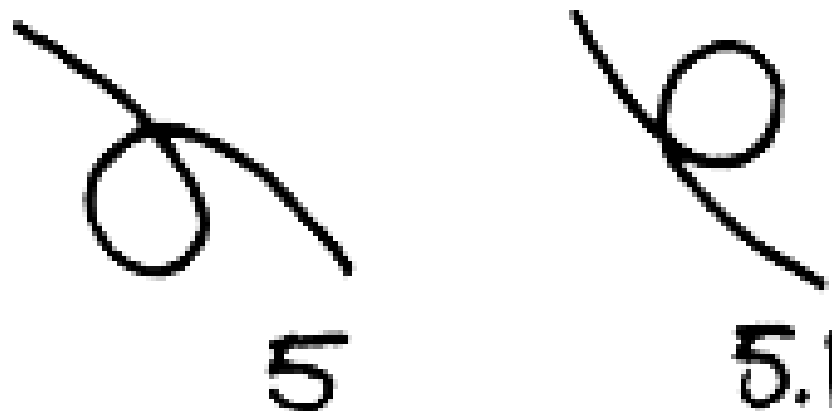

Figure 28 - Solution 5 & 5.1

Solution	Feet	MI/min 1	MI/min 2	MI/min 3	Average	Difference from baseline
Baseline	2	101	99	99	99.3	x
Solution 5	2	100	101	101	100.7	1.4%
Solution 5.1	2	99	98	99	98.7	0.6%

Table 15 - Solution 5 & 5.1 - 100ml/min

Solution	Feet	MI/min 1	MI/min 2	MI/min 3	Average	Difference from baseline
Baseline	2	50	49	50	49.6	x
Solution 5	2	49	49	50	49.3	0.6%
Solution 5.1	2	50	51	51	50.7	2.2%

Table 16 - Solution 5 & 5.1 - 50ml/min

Solution 6

Solution 6 was added later, due to new design needs. Figure 29 shows the variations of the solution, table 17 shows the results of the test performed with a flow rate of 100ml/min and table 18 shows the results of the test performed with a flowrate of 50ml/min.

Conclusion

Solution 6 passes this test.



Figure 29 - Solution 6

Solution	Feet	MI/min 1	MI/min 2	MI/min 3	Average	Difference from baseline
Baseline	2	100	101	100	100.3	x
Solution 6	2	101	101	100	100.6	0.3%

Table 17 - Solution 6 - 100ml/min

Solution	Feet	MI/min 1	MI/min 2	MI/min 3	Average	Difference from baseline
Baseline	2	50	51	51	50.7	x
Solution 6	2	49	50	51	50.0	1.4%

Table 18 - Solution 6 - 50ml/min

7.4.4 Materials and manufacturing

Copper is the most conductive metal and would be ideal as the metal plate. This material is available in Nepal and is easy to work with.

A sheet of copper that is 0.5mm thick or less can be cut with scissors, therefore people putting together the fluid warmer won't need specialised equipment. A template can be downloaded and stuck on top of the sheet for easy cutting. The clamps can also be easily bended with a sheet of 0.5mm thickness and a template. These pieces can be stuck together on the designated places with a heat resistant epoxy adhesive. Super glue, or other easily available adhesives could be used, but are not as heat resistant and could be compromised over time.

7.4.5 Conclusion

The following solutions could be implemented:

- Solution 2
- Solution 4
- Solution 4.1
- Solution 4.2
- Solution 5
- Solution 5.1
- Solution 6

Solution 2.1 did not pass the test. Due to the big difference in ml in this test this could be because of operator error.

7.5 Subproblem 3: Electronics

7.5.1 Introduction

To make the fluid warmer open source, the electronics also need to be open source and easily available. This can be achieved by using an Arduino board to operate the fluid warmer. Arduino is available in Nepal, and in most other countries around the world. The code can be open source while providing instructions on how to install all the components.

7.5.2 Components

The different components needed are:

Arduino Nano

The reason there was chosen for the Arduino Nano is because the Arduino Nano is a lot smaller than an Arduino Uno or Mega and is able to provide a comparable functionality. There are not many pins needed, and other Arduinos may have an excessive amount of pins while being more expensive.

LCD Screen

A screen is needed for the user to be able to monitor the output temperature and the user to set a temperature and/or flowrate.

Potentiometer

The potentiometer is used to set a temperature and/or flowrate.

Buzzer

The standard specification calls for an audible alarm, and the buzzer provides this.

LED

The standard specification calls for a visible alarm, and the LED provides this.

Heating element

As discussed in earlier chapters, the heating element will provide the heat to warm the blood.

220V plug

This plug is needed to power the heating element.

Resistor

A resistor is needed to make the heating element less powerful to have better control over the temperature.

Temperature sensor 1

The first sensor is needed to monitor the temperature of the heating element.

Temperature Sensor 2

Sensor 2 is needed to monitor the output temperature of the blood.

After talking with Sudip Phuyal, Co-founder and CEO of the Robotics Academy of Nepal, (LOG, appendix pg.5) the decision was made to also use the following parts.

- Rotary encoder instead of potentiometer
- Relay
- Board for soldering
- Voltage regulator

A detailed instruction on how the Arduino should work was written (appendix pg.40) and writing of the Arduino code was then outsourced to Sudip Phuyal. The Arduino parts were soldered onto a board. This was not discussed, and the Arduino therefore did not fit in the 1st casing. The decision was made to change the casing to include the board because soldering the Arduino part onto the board makes the chances of the Arduino malfunction less. This is due to the good connections between parts.

7.5.3 Block diagram

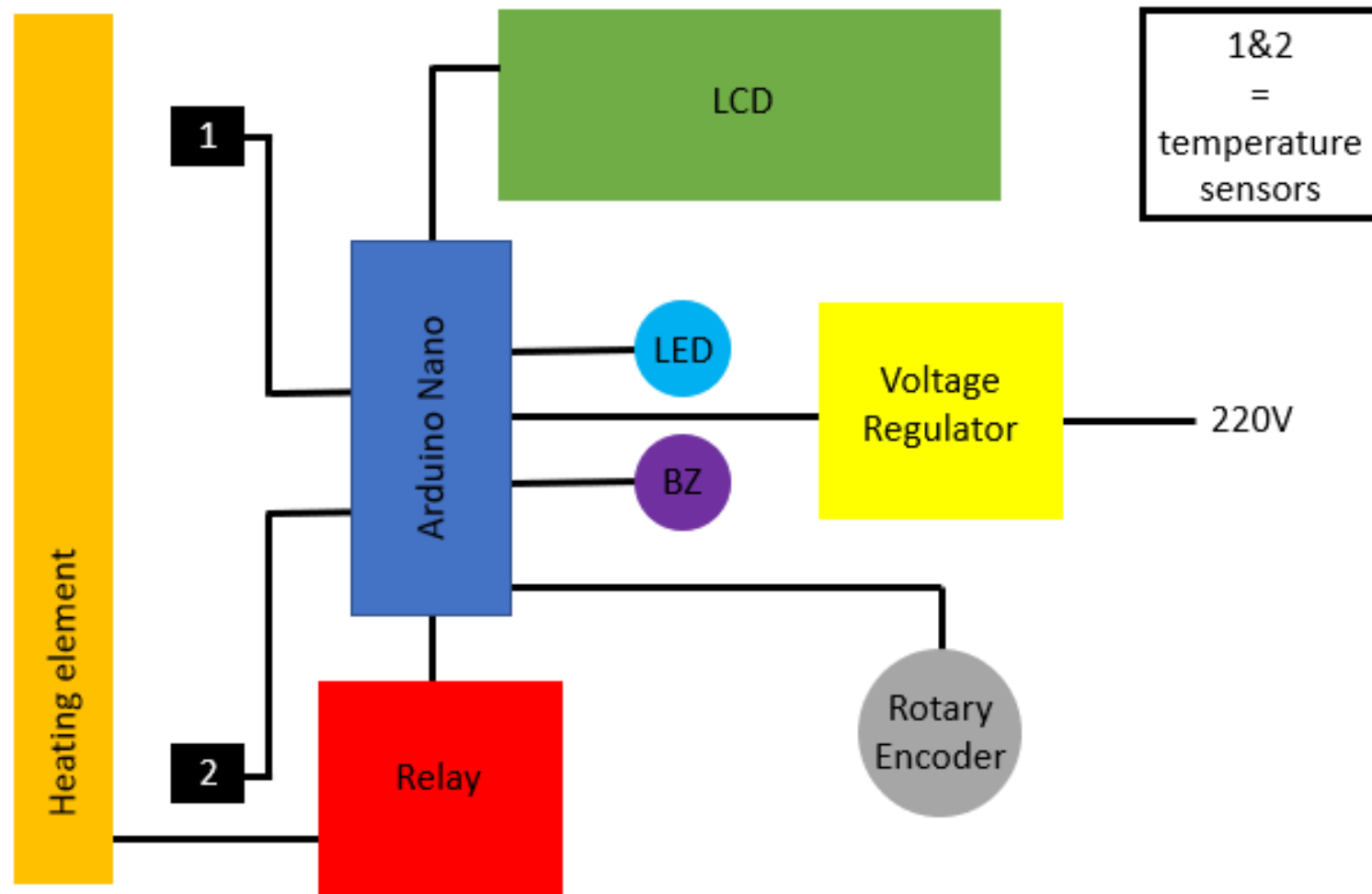

The outside temperature of the IV line may differ from the temperature of the blood that is traveling through. To make sure there is an accurate temperature reading at sensor 2 a test must be conducted.

While measuring temperature of the outside of the IV line at sensor 2, the output temperature of the fluid is also measured. The two temperatures must be compared, and the difference must be recorded. Figure 30 shows a testing setup.

The suggestion is made to perform this test before starting tests with blood.

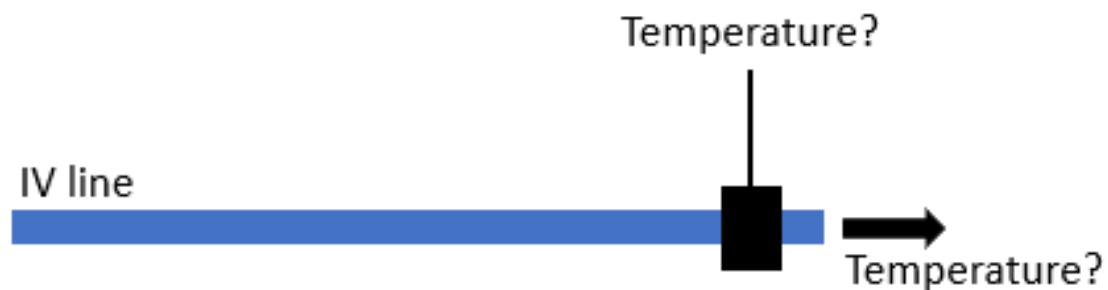

Figure 30 - Test setup

7.5.4 Test

The code was checked by going through the code to see if all the features added in the instructions were met. This was done with Kieran Ram.

Kieran Rams was asked what his thoughts on the code are:

“The code is very messy. It is very hard to follow along with what he has written, and some parts don’t make sense. The code does work. I would suggest that someone else rewrite the code to make sure that the code is neat and logical, and that a chance of failure do to us overlooking a function in the code is smaller.”

7.5.5 Safety features

The code is written to have a LED and a buzzer included. If the temperature of the 2nd temperature sensor (monitoring the blood temperature) goes over 37°C the light and the buzzer will go off to warn doctors and nurses. This is however highly unlikely to happen due to the rest of the code being written to prevent the temperature of the blood going over 37°C by using the previously done calculations.

As a safety feature the first temperature sensor works as a thermal fuse. This is the temperature sensor that measures the temperature of the heating element. If this temperature goes over 85°C, the fuse will melt, and the circuit will be broken causing the fluid warmer to shut off. This means the temperature will never go higher than the temperature set on the thermal fuse. This thermal fuse has not been tested. Suggested is to test 10 of these thermal fuses

7.5.6 Conclusion

The code written by Sudip is very messy and needs to be revised. An LED, buzzer and thermal fuse were added as safety features.

7.6 Subproblem 4: User interface

7.6.1 Introduction

The user interface is what the biomedical engineers, doctors and nurses interact with. This interaction needs to be intuitive to cut down on the amount of time it takes to learn how to work with the fluid warmer.

7.6.2 Sketches

Figure 31 shows sketches of the brainstorm about the user interface.

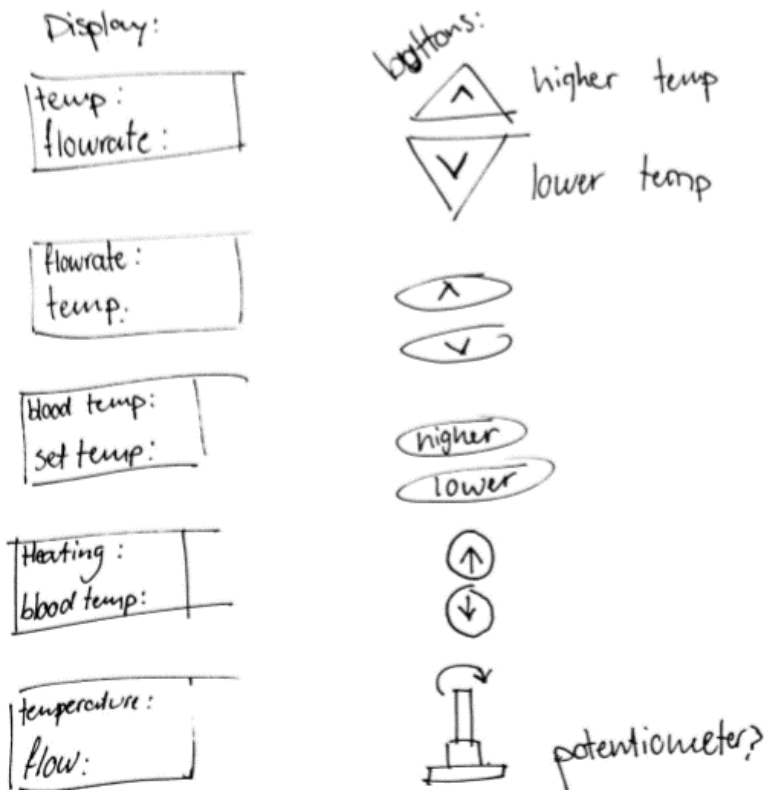

Figure 31 - Brainstorm

7.6.3 Design choices

Instead of having the temperature of the heating element being the input, there was decided to input the flowrate. The flowrate has a direct effect on the temperature of the heating element. If the user puts in a flowrate, the heating element will go up to the correct temperature. This is shown in table 19.

Flowrate	Temperature of heating element
Less than 8.5 ml/min	37
8.5 - 9.9 ml/min	50
9.9 - 14.9 ml/min	60
15 - 19.9 ml/min	70
20 ml/min or higher (up to 100 ml/min)	80

Table 19 - Flowrate to temperature

The choice was made to use a potentiometer instead of buttons to decrease the number of Arduino parts needed and be able to more accurately input the flowrate without endlessly pressing a button.

There was chosen to display the current temperature of the blood and the flowrate. The standard specification show that the current blood temperature must be displayed. A mock-up of the LCD-screen is shown in figure 32.

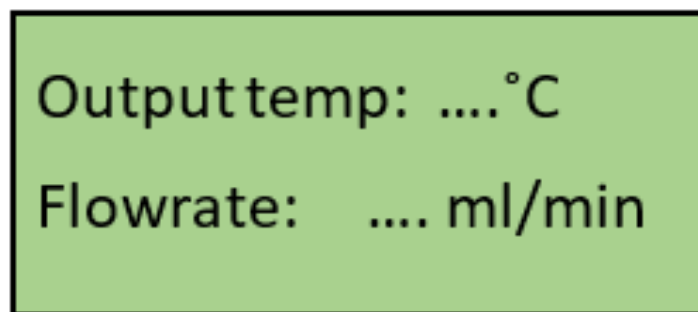

Figure 32 - LCD-screen mock-up

7.6.4 Feedback

The design choices were shown to Er. Kishor Bhandari. The following feedback was received when asked his opinion on how the device functions:

"We don't have the possibility to calculate the flowrate as accurately as you have put on the display. This will not work for us. Here in the hospital the doctors only work with fast, medium and slow flowrates because there is no way for us to do transfusions more accurately. Please put the following flowrates as slow, medium and fast; Slow – below 10 ml/min, Medium – between 10 and 20ml/min, and fast, over 20 ml/min."

The flowrate in Nepal cannot be accurately administered. The flowrate is controlled with clamps. This doesn't benefit the transfusion. The safety measures in the Arduino are now even more important to stop the blood from overheating since the administered flowrate is an educated guess.

7.6.5 Adjustments

Based on the feedback received from Er. Kishor Bhandari the depiction of flow rate was changed from displaying the accurate flowrate to working with slow, medium and fast. This is shown in table 20.

Flowrate	Temperature of heating element
Slow (below 10ml/min)	50°C
Medium (between 10 and 20ml/min)	65°C
Fast (20 ml/min or higher)	80°C

Table 20 - New flowrate to temperature

7.7 Subproblem 6: IV stand connection

7.7.1 Introduction

The fluid warmer must be between the bag and the patient. The bag of blood or other fluids is always on an IV stand. The fluid warmer can also be installed on this IV stand. The IV-stands at ANI have a diameter of 40 mm (Er. Kishor Bhandari, 18-12-2017, LOG, appendix pg.4).

7.7.2 Sketches

Figure 33 shows sketches of a brainstorm about the IV pole connection. More variations can be found in appendix pg.42.

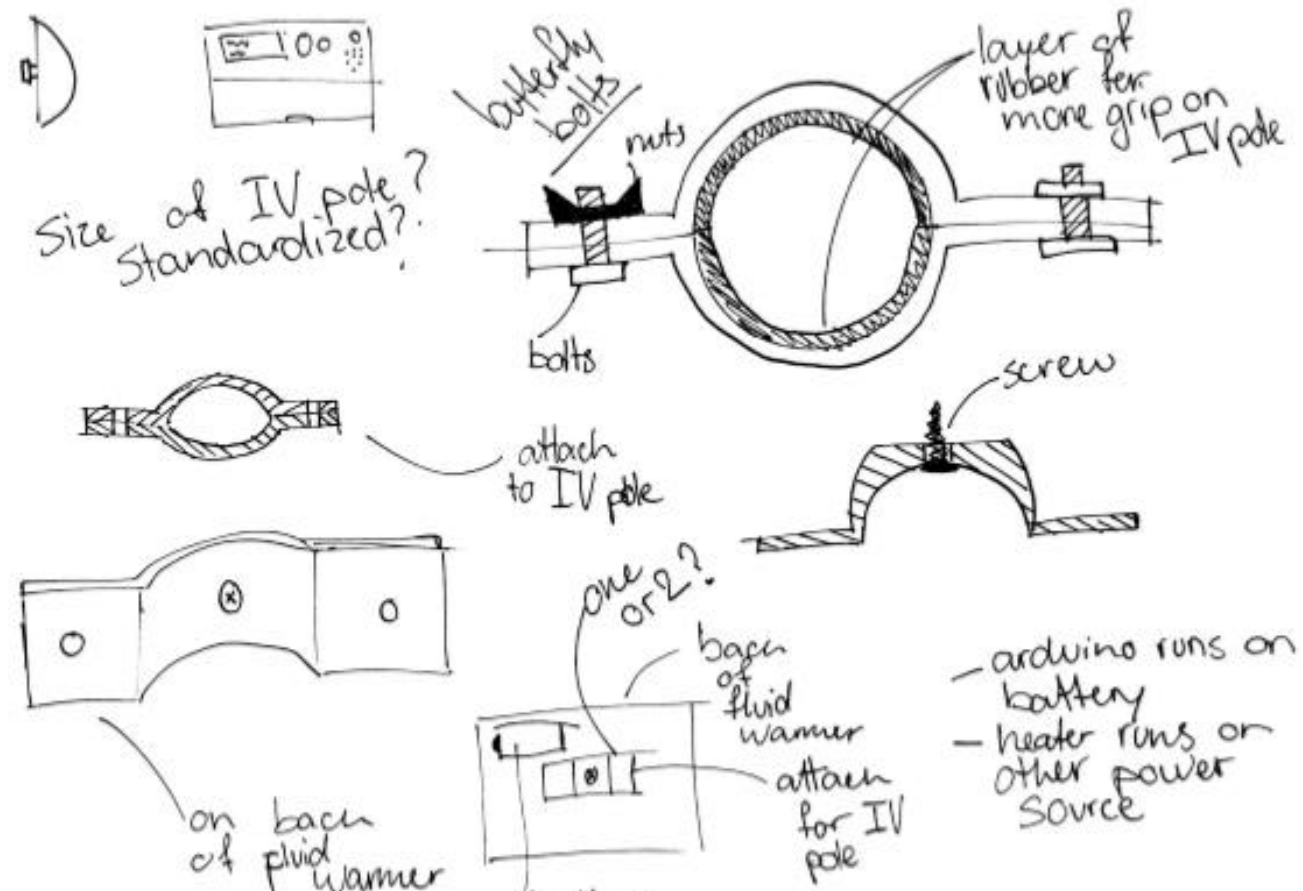

Figure 33 - IV pole connection sketches

7.7.3 3D-CAD

Figure 35 shows the assembled IV stand holder. Figure 34 shows the different elements of the IV stand holder.

1. Bolts
2. Nuts

The choice to use bolts and nuts was made due to their availability. Bolts and nuts are easily available in Nepal and in most other countries, and are easy to use.

3. Protrusion

This protrusion is added to make placement on the main body easier. It shows exactly how the holder needs to be fastened.

4. Diameter

The diameter on this holder is 40mm to fit the IV stands in ANI. The holder will only fit this diameter.

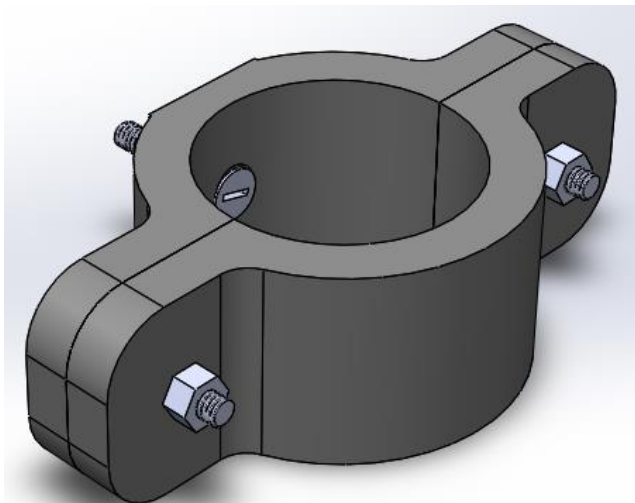

Figure 35 - Assembled IV stand holder

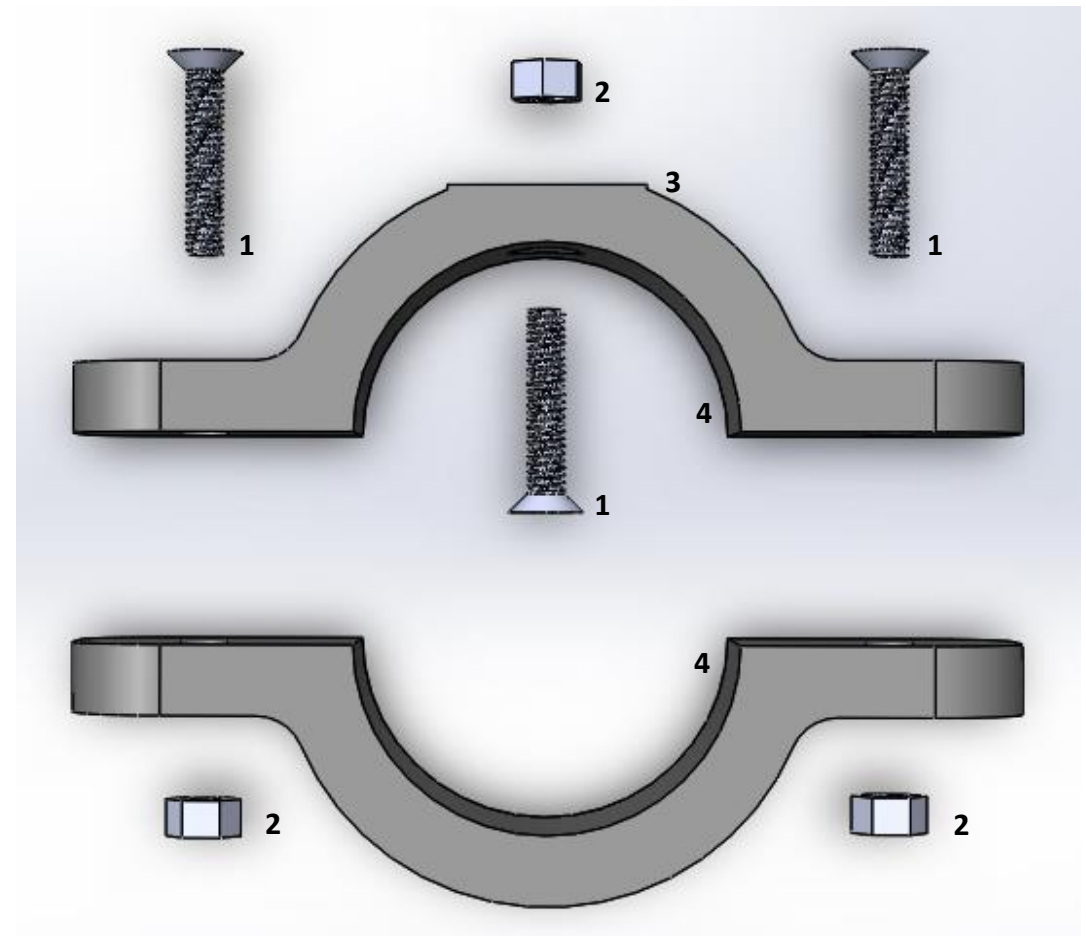

Figure 34 - Exploded view IV stand holder

7.7.4 Prototype

The prototype in figure 36 is 3D printed with white ABS filament.

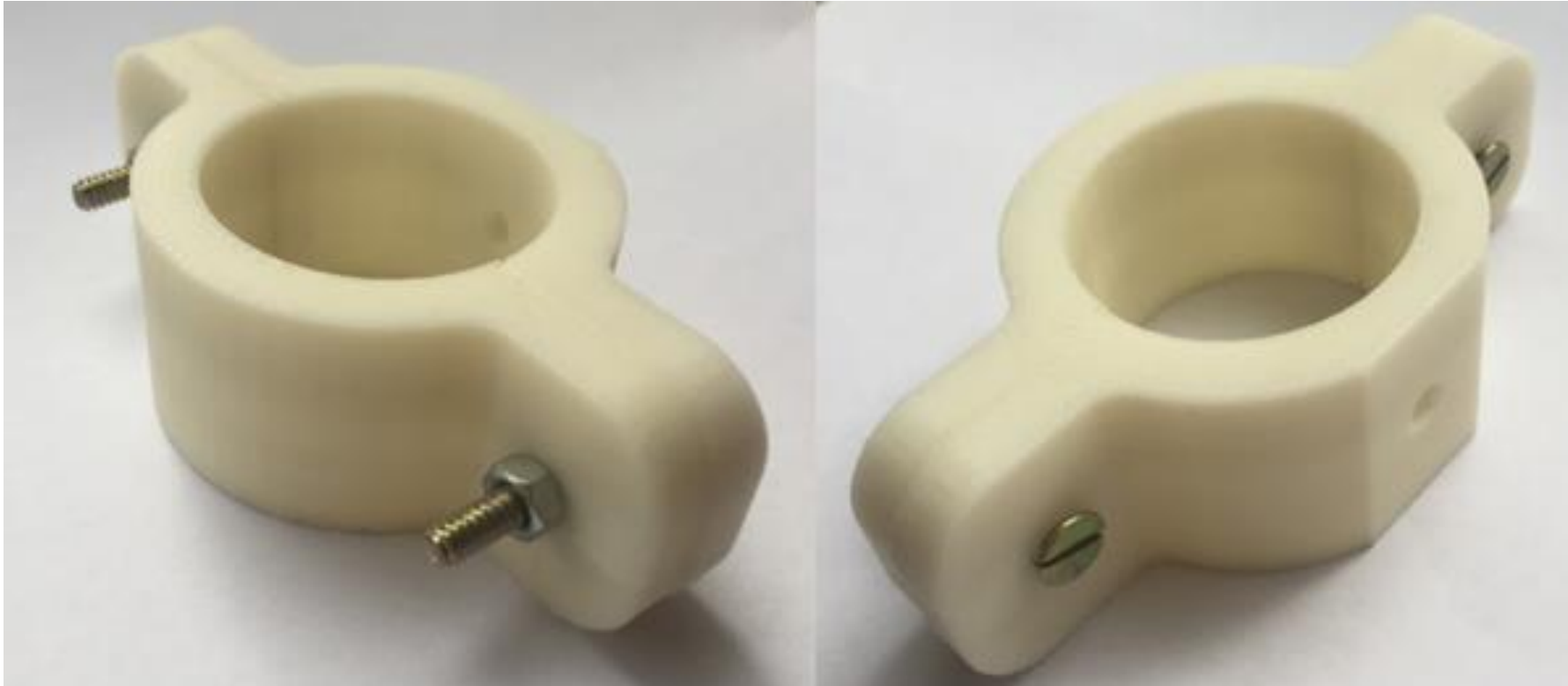

Figure 36 - Prototype of the IV stand holder, front and back view

7.7.5 Test & Feedback

By attaching the IV stand holder to a 40mm tube and attaching a weight the hold of the holder was tested. Figure 37 shows the IV stand holder attached to a 40mm tube. Figure 39 shows the holder on the back of the casing and figure 38 shows the holder with weights attached in the previously mentioned test.

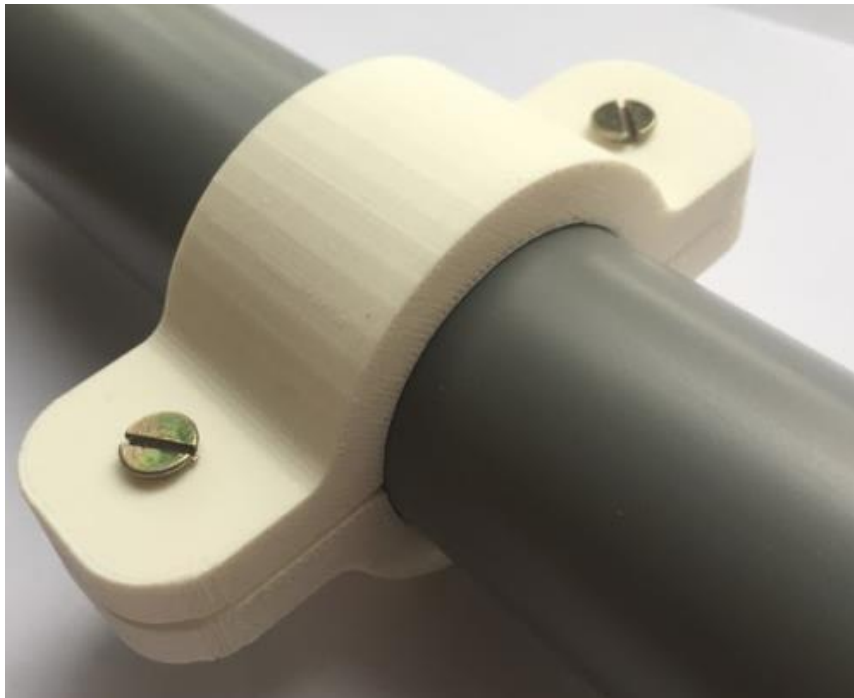

Figure 37 - IV stand holder on 40mm tube



Figure 39 - IV stand holder on the back of the casing

Conclusion

Figure 38 shows that the IV stand holder can hold a weight of at least 3kg.

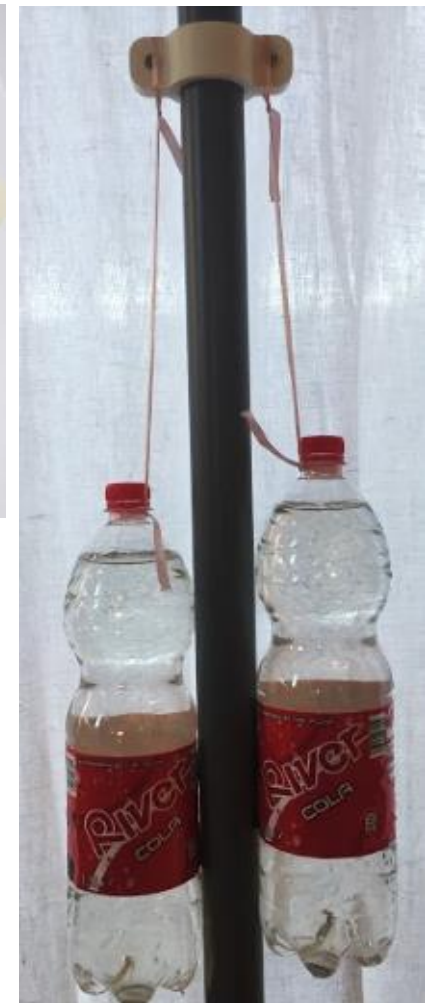

Figure 38 - IV stand holder holding 3kg

Test at ANI

To test the IV stand holder Er. Sonam Subba was asked to attach the holder with the housing construction to a IV stand in ANI. This is shown in figure 40 The goal of this test was to test usability.

Er. Sonam Subba was asked about his experience of attaching the fluid warmer to the IV pole:

“I really like the idea of attaching the device to the IV pole because this makes it very easy to set up the fluid warmer. The two bolts, however, take a bit of time to fastened. If you could change this to make it easier to fastened, and remove, then the device would become even more portable and we would be able to help a lot of patients very efficiently.”

Er. Kishor Bhandari was asked about the design of the holder:

“The device would be able the fit on the IV stand, and would not be in the way there. I can easily use it from there. Not all IV stands are the same width. Maybe you can add an extra screw in the back, so you can make the holder smaller from there, so we can fit the device on every IV stand.”

Conclusion

The IV stand holder should be easier to fastened and unfastened, and should be applicable on different sizes of IV stands.



Figure 40 - Er. Sonam Subba testing the IV stand holder

7.7.6 Adjustments

After the feedback from ANI, there was decided to exchange the nuts used to fasten the fluid warmer to the IV pole with winged nuts for easier fastening and loosening. The bolt was also shortened to save time of fastening a loosening.

The bolt that attaches the holder to the fluid warmer did not sit flush with the curve of the holder. This is shown in figure 41. This is changed to prevent the gap shown.

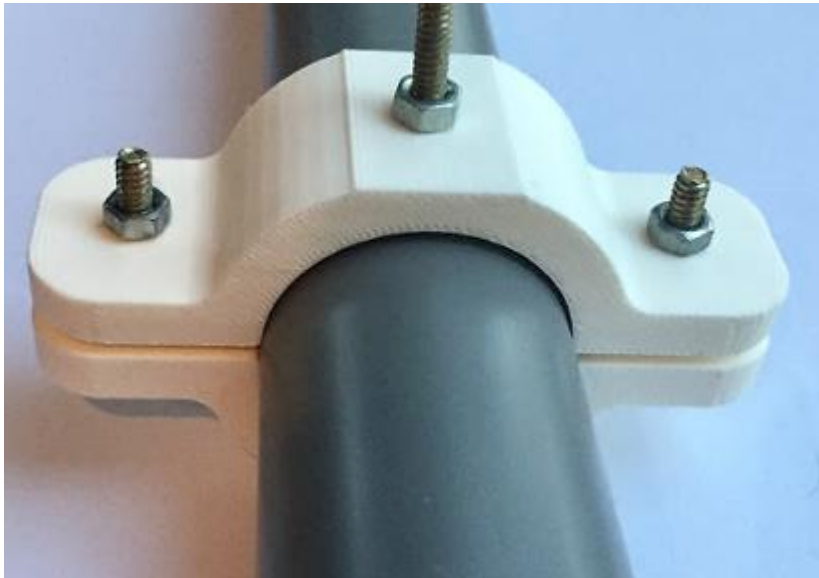

Figure 41 - Gap between holder and IV pole

Students from the Rotterdam university have been working on a similar project. They have made prototypes of IV pole holders that are 3D-printed. Their ideas are great, and it would be mutually beneficial to work together.

The design of the fluid pole holder was a side issue in this project. The students may have better ideas as this was their main focus.

7.7.7 Materials & Manufacturing

The IV pole holder will be made with a 3D printer. This will enable the design to be customized to different sizes of IV poles. There are going to be multiple open source files for this product, to ensure that every hospital can download the holder with the size that fits their IV poles best.

His product will be printed with ABS, for its durability and strength.

7.7.8 Conclusion

The design made can be used as an IV pole holder. Students from Rotterdam university have worked on a similar project and working together is recommended.

7.8 Housing construction

7.8.1 Introduction

The casing is the part of the fluid warmer that holds the rest. In this chapter the findings from other chapters will come together to form one design.

7.8.2 Casing 1

Brainstorm

Different ideas were generated. Appendix pg.43 has more options that were considered.

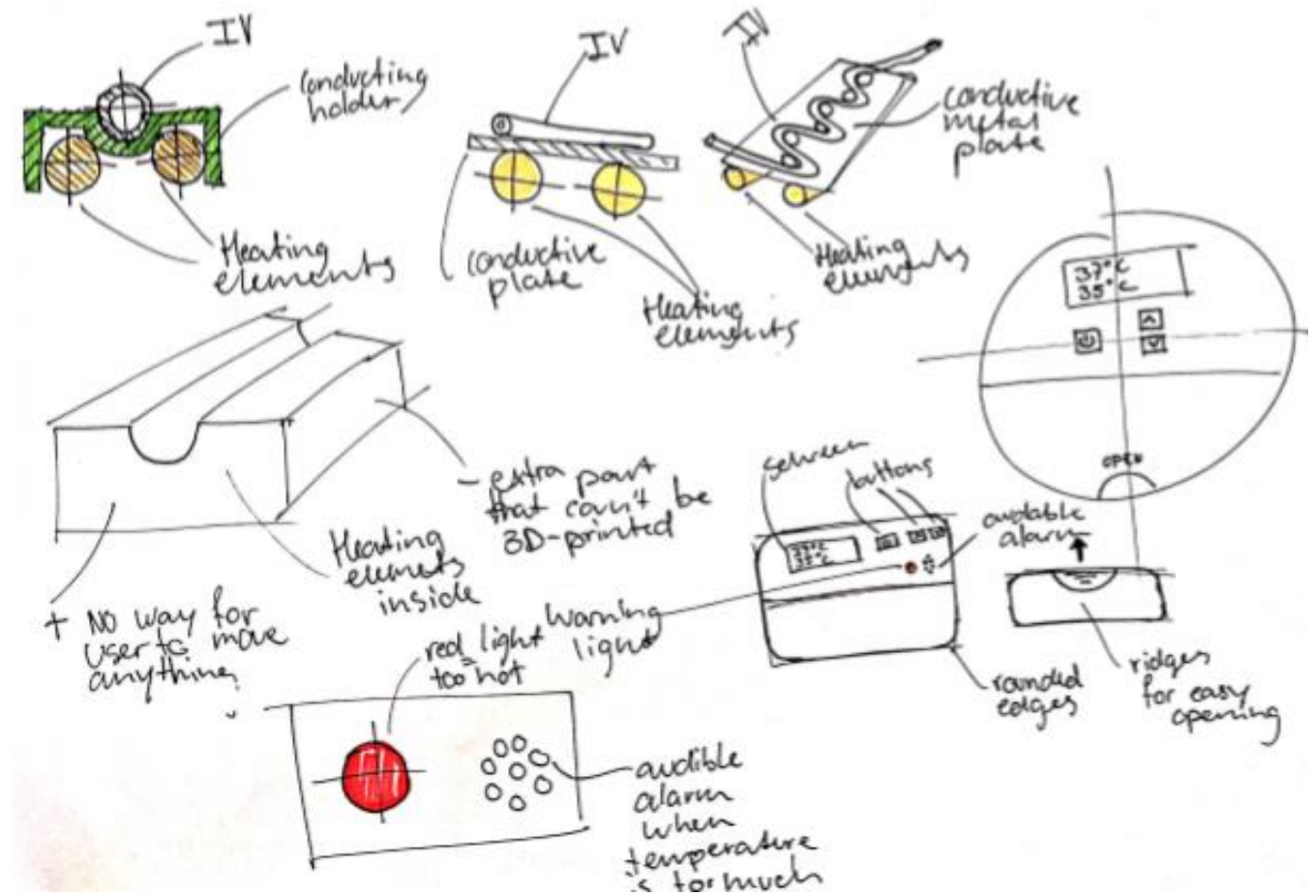

3D-CAD

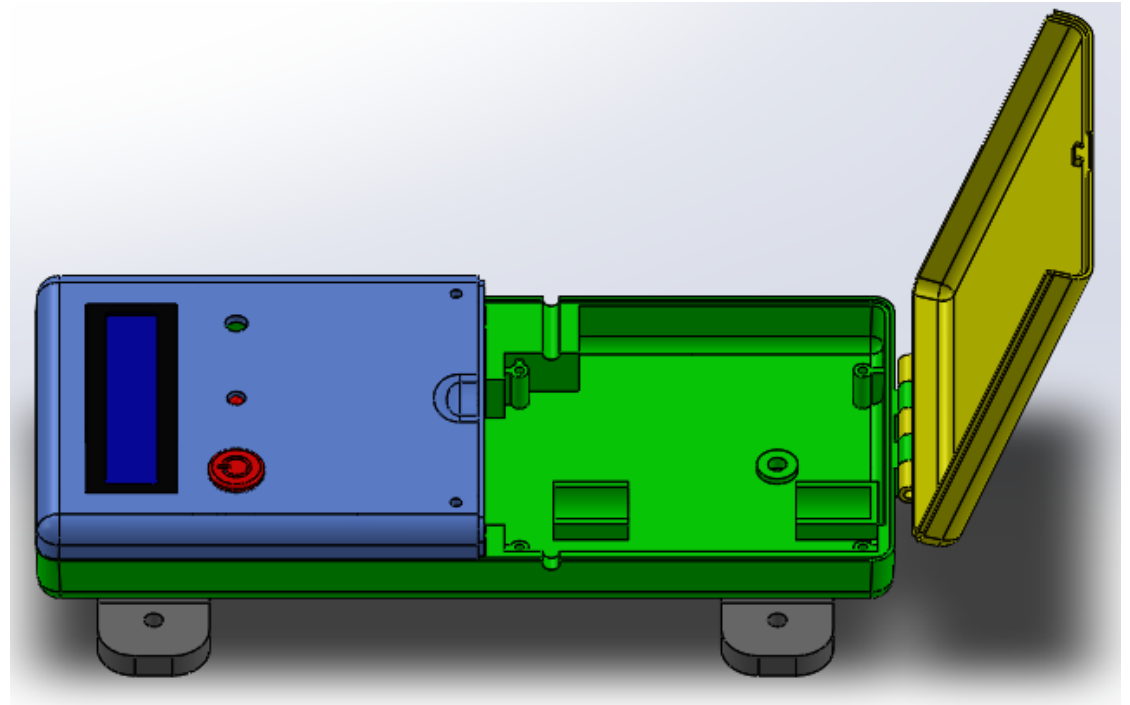
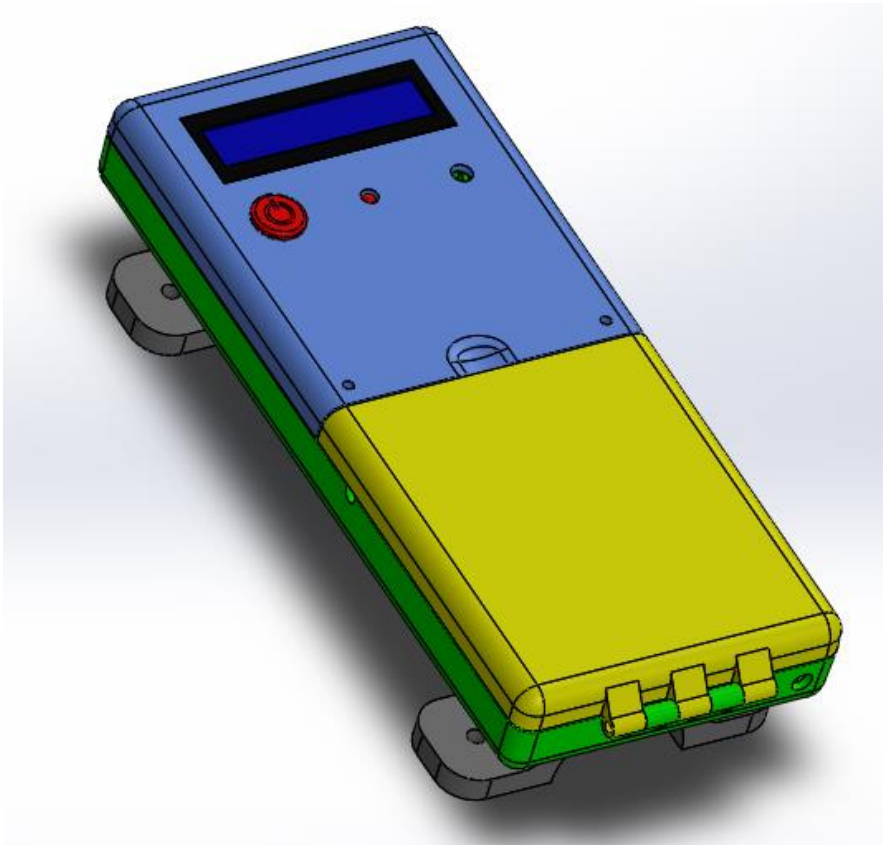

Lip-groove

The casing of the fluid warmer is made with a lip groove. This is to take into account the possibility of shrinking during the 3D-printing process, which could be caused by differed in temperature of the printers. In figure 42 can be seen that the gap between the two parts is 0.5mm.

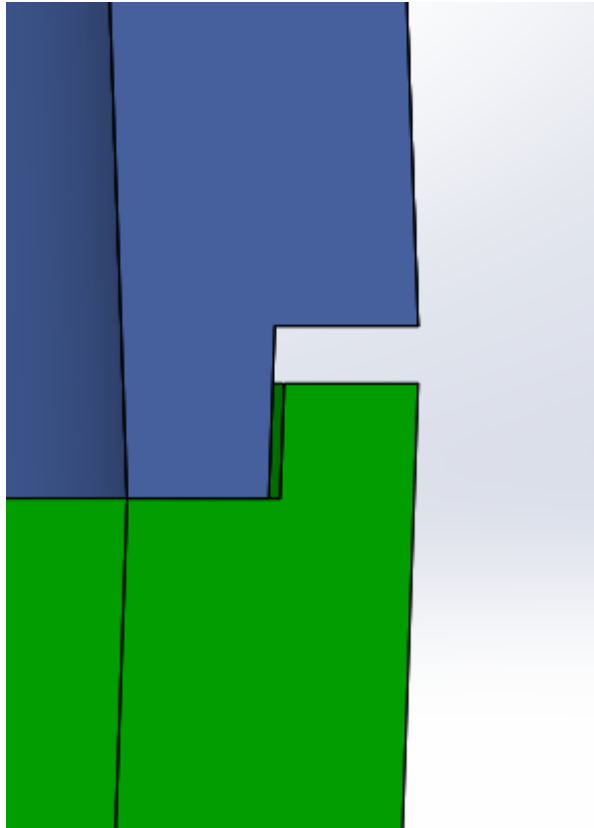

Figure 42 - Lip-groove

A gap between the parts is not very hygienic. This might be a problem in first world countries. While doing projects for Erasmus MC it was emphasised that there should be no gaps between parts. In this instance it was made clear that for ANI this gap was not an issue. This is a big difference between the way of thinking in these hospitals. The fluid warmer does not need to be sterile and for that reason the gap between these parts can be tolerated.

The front of the fluid warmer gets attached to the back casing with 2 screws. Th lip-groove helps keep it in place and aligns the parts. In the first version of this casing the thickness was 2mm. This was changed to 2.5mm to add more strength in the walls of the product.

Hinge

The first hinge designed was with the hinge inside the fluid warmer. This decreases the areas that can get dirty, but this hinge could not function without big gaps in the casing. Figure 43 shows the hinge.

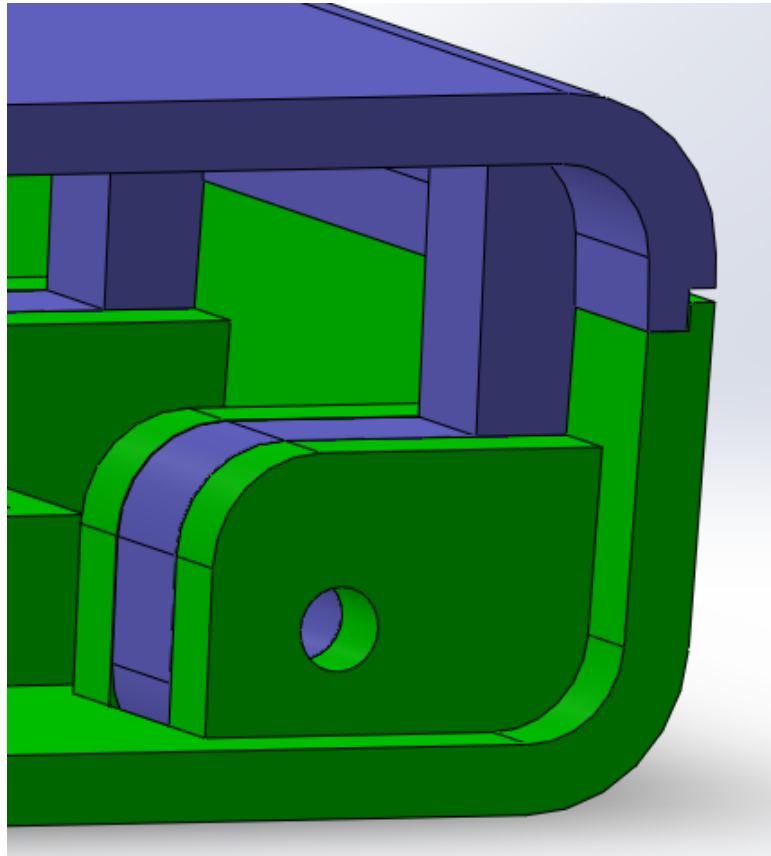

Figure 43 - Hinge in a section view of the fluid warmer

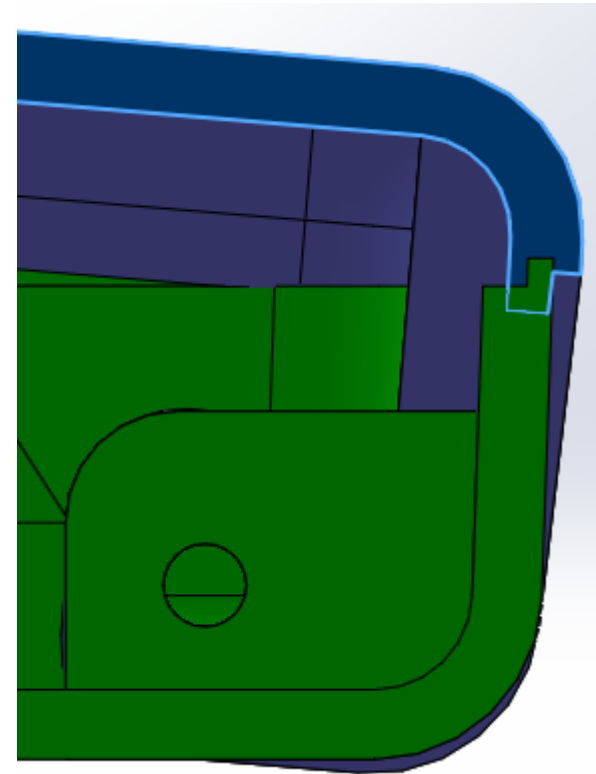

Figure 44 - Overlap between the 2 parts

Figure 44 shows that when the hinge is opened without gaps the 2-part overlap. When adding gaps, the fluid warmer becomes less hygienic, and therefore there was chosen to make a different hinge.

Figure 45 shows the second version of the hinge. This hinge works without gaps that let dirt into the fluid warmer.

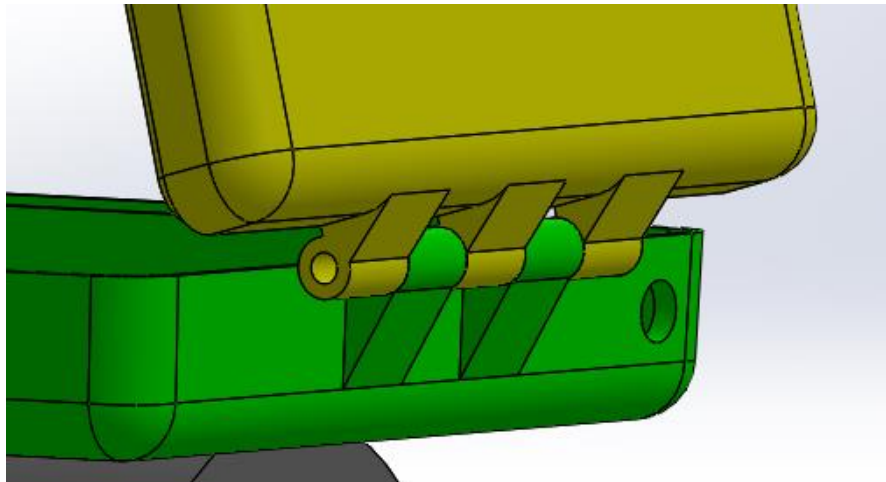

Figure 45 - Version 2 of the hinge

This hinge is held together by M3 thread with nuts and washers on each end. This is easily available in Nepal and a solution that anyone can put together.

In this model there is no gap between the parts of the hinges. While testing with the prototype this meant that the hinge opened very rigidly. To change this a 0.5mm gap between parts of the hinges was added. In figure 46 the hinge is open, and because of the lack of gap this could happen without thread. This is changed to make the hinge open more smoothly.

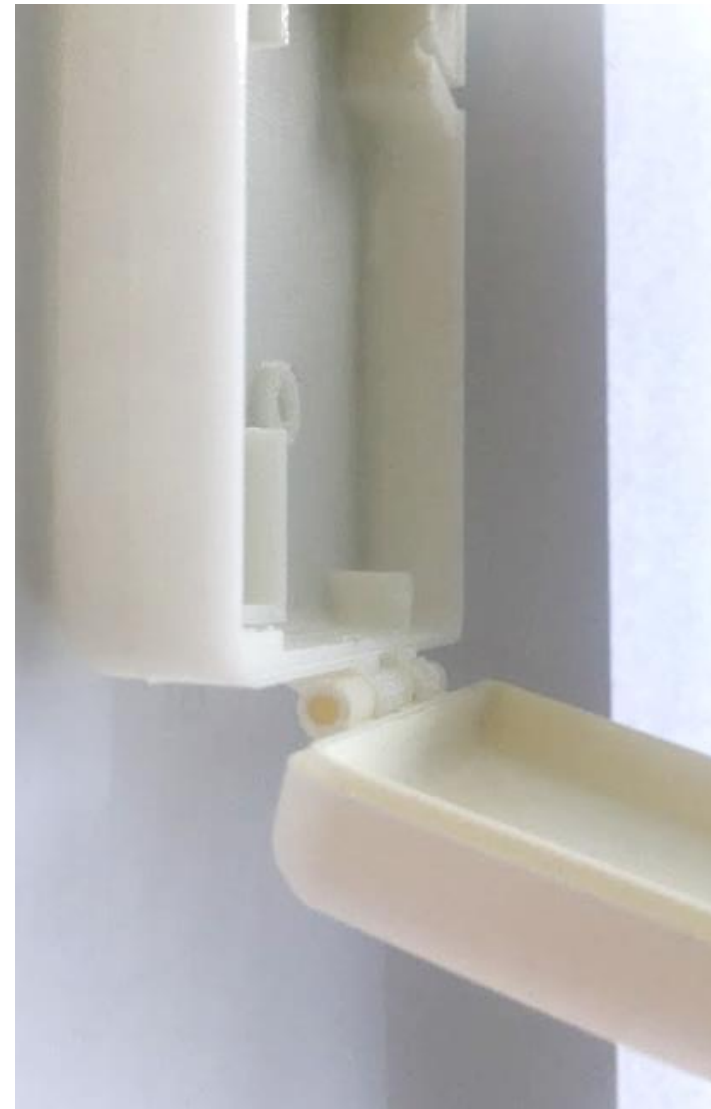

Figure 46 - Prototype hinge

IV pole holder connection

A little extra material was added on the inside of the fluid warmer where the IV stand holder connects to the fluid warmer to give this area a little more strength. Figure 47 shows the prototype.

This was added in the second version of this casing. After identifying this as a weak spot the extra material was added.



Figure 47 - Extra material at the base of the nut

On the other side of the fluid warmer a small cut-extrude of 0.5mm is made. This is for the IV stand holder to fit into and show in what direction the holders should face. This is shown in figure 48.

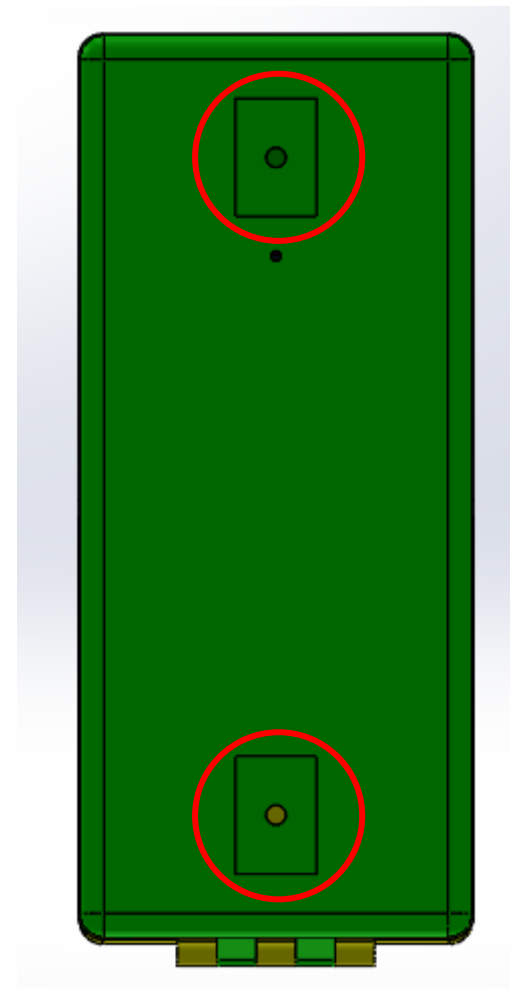

Figure 48 - The red circles show the location of the cut-extrude for the holder

Heating element

The heating rod was chosen as heating element in this casing. This is due to the size being smaller and more practical than the immersion heater. Figure 49 shows where the heating rod can be installed.

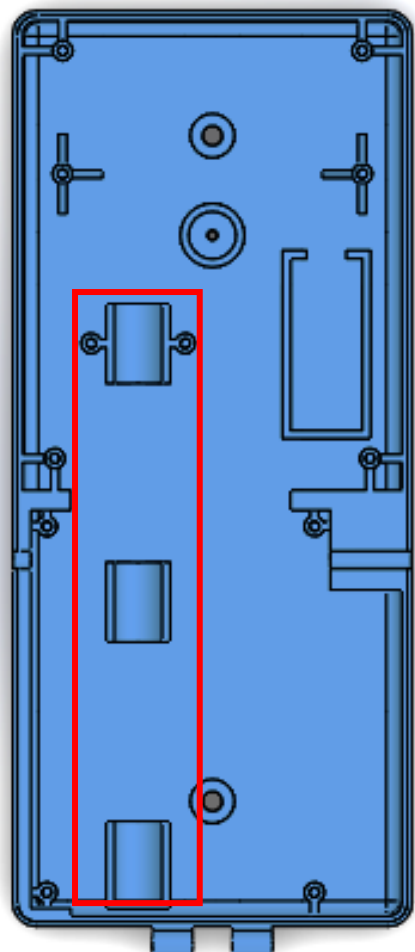

Figure 49 - The red rectangle shows the heating rods place

The heating rod is kept in place by an extra part (figure 50) and 2 screws on one side, and the copper plate on the other. The copper plate and the heating element are not in much contact due to the heating element being a cylinder, but because copper is so conductive this is not a problem.

In an earlier version of this casing the heating element was centred in the casing. This was changed after it was deemed more important that the IV stand holders were centred.

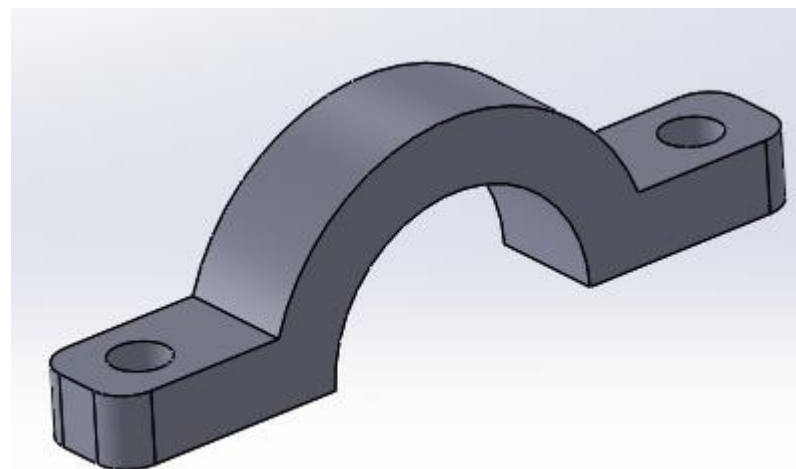

Figure 50 - Part that keeps the heating rod in place

Copper plate

There was chosen to use fluid path 4 in this casing. This was because the size of the place the IV line needed to be is small compared to the rest of the fluid paths. The IV line in this model does cross over itself, as seen in figure 51, and therefore doesn't have the most contact with the surface of the copper plate. This could influence the heating of the IV tube.

The copper plate has one clamp, and is attached to the casing with 4 screws. The holes for the screws are designed to be sturdy, but not waste a lot of material. This can be seen in figure 51. Other designs for the clamp can be found in the brainstorm in appendix pg.44.

The copper plate is 0.5 mm in thickness. It is not recommended to exceed that because that causes it to become too difficult to bend by hand.

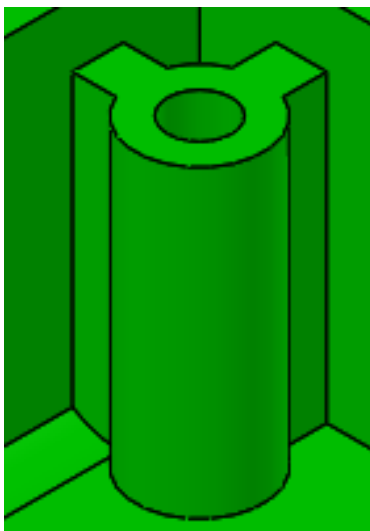

Figure 52 -Example of hole for screw



Figure 51 - Copper plate in the fluid warmer

Closing

Different closing mechanisms were considered. The brainstorm is shown in appendix 45.

For the fluid warmer to be able to function properly, the hinging part of the fluid warmer needs to be able to stay closed during use. This prevents heat from escaping, and keeps the IV line in place. The section view in figure 54 shows this. Figure 55 shows a different viewpoint.

The orange rectangle shows that a dip is added in the casing for the fingers. This also shows where the closing is.

The green rectangle shows that the hinging part overlaps with the casing. This is to minimize the gap between the two parts.

The red square shows that there is an area of the hinging part that gets stuck behind the top. This is what keeps the fluid warmer closed. The overlap is so minimal that it still can be opened.

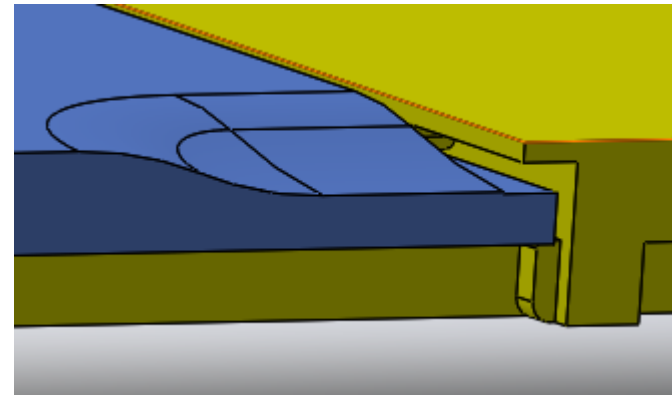

Figure 54 - Different viewpoint

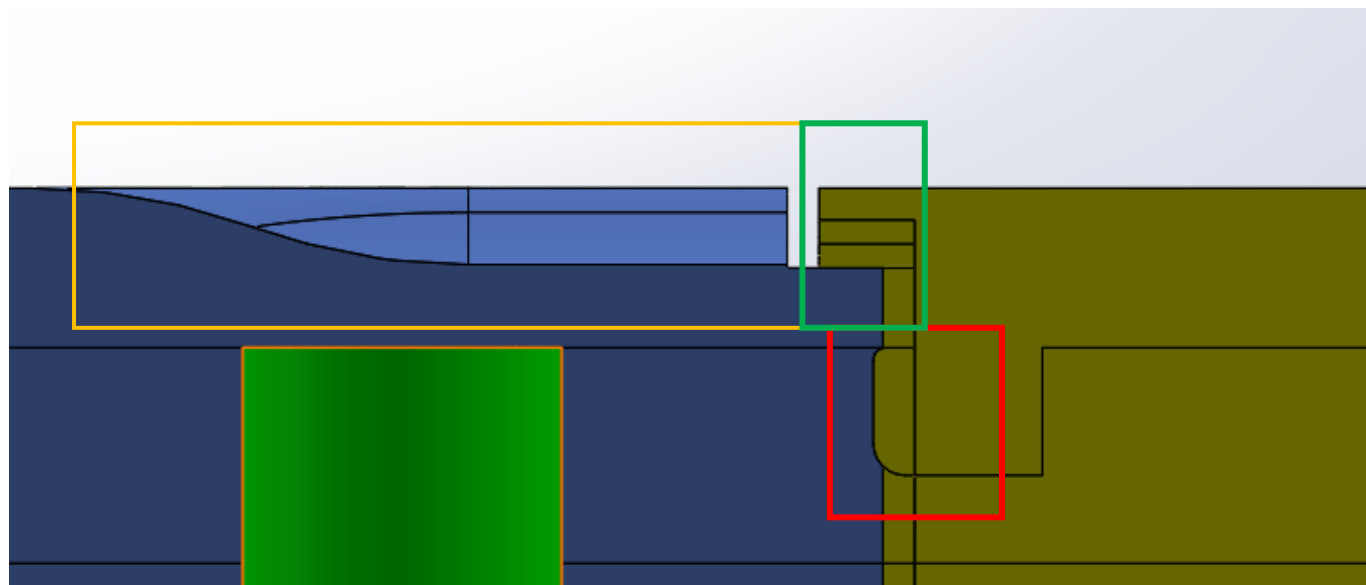

Figure 53 - Closing of the fluid warmer

Prototype



The first prototype did not print. This was due to a power cut that happened during printing. This happens often in Nepal and when it happens the print needs to be started again. The unfinished prototype is seen in figure 56.



Figure 55 - 3D print that stopped due to power cut

Test & feedback

The casing was shown to Er. Kishor Bhandari and Er. Sonam Subba at ANI

Feedback from Er. Kishor Bhandari when asked about the design on the fluid warmer, and when asked about the finish of the 3D print:

“The casing looks good. It is something that would fit into a hospital environment. The area with the hinge is easy in use. I think that the nurses and doctors in the hospital would be able to use it. It would take a 5-minute explanation and demonstration I think. I would change the amount of clamps on the copper part. I think one is not enough.”

“You don’t need an extra finish on the 3D-print. The layers are thin enough that it can be used without dirt going between the layers.” Figure 57 shows Kishor pointing out the place where an extra clamp would be needed.

Feedback from Er. Sonam Subba when asked his opinion on the design:

“I like the design you made. You almost don’t need an explanation to use it. It is very natural. If I could change something I would make even smaller to make it more portable.”

The design has also been tested on spillage. This is a requirement. The test is shown in appendix pg.46.

Adjustments

This casing was made for all the Arduino to fit inside, however, the Arduino was soldered to a base plate. Due to this the Arduino will not fit in this version. There was decided to make a new casing because the base plate makes the Arduino easier to install and less prone to mistakes.



Figure 56 - Er. Kishor Bhandari with the prototype

7.8.3 Casing 2

Brainstorm

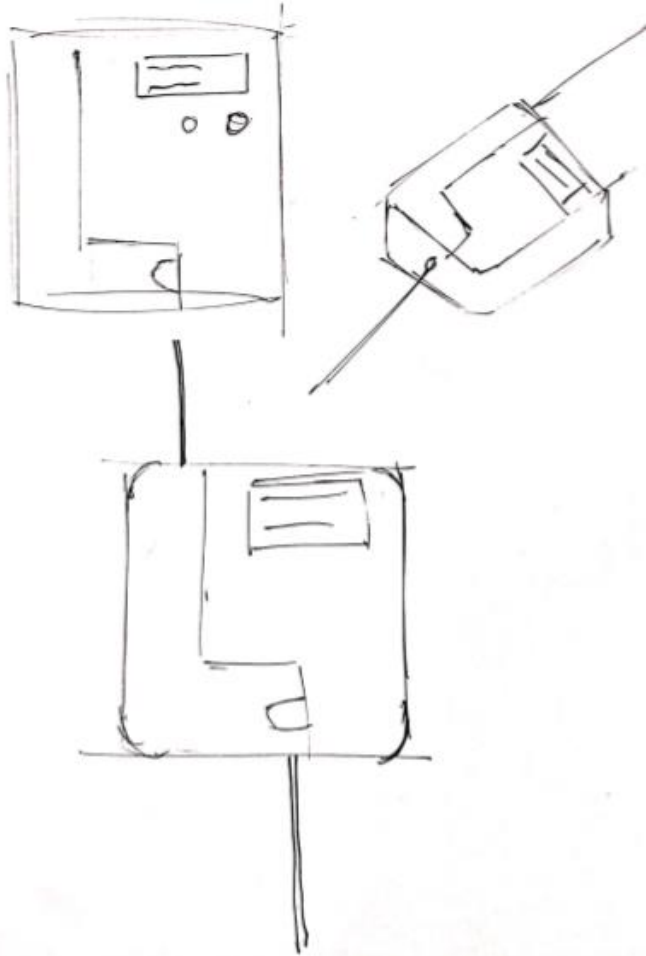

3D-CAD

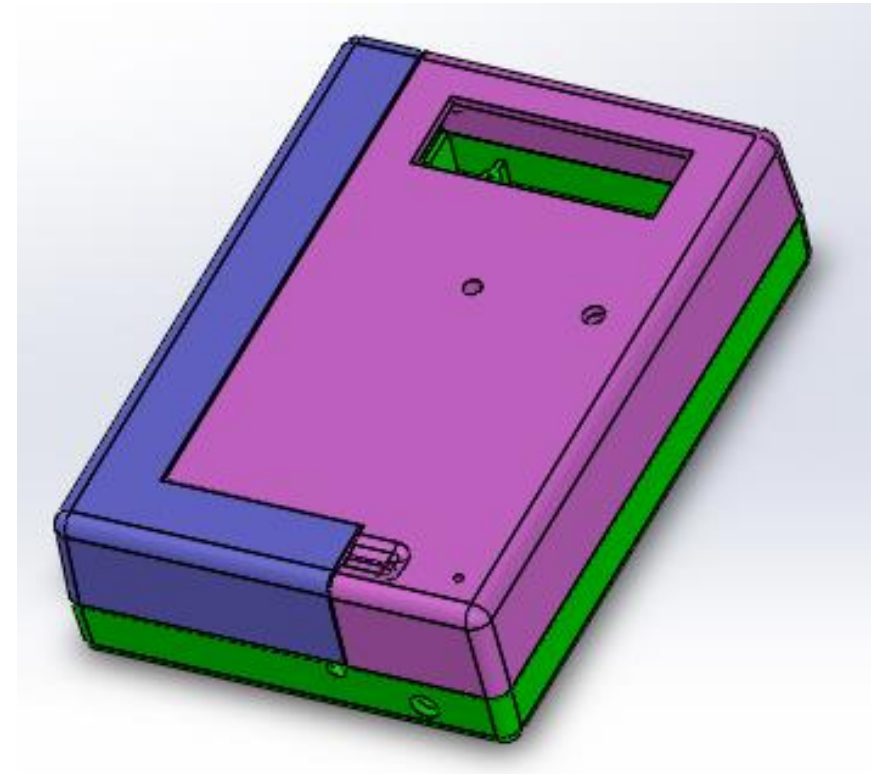

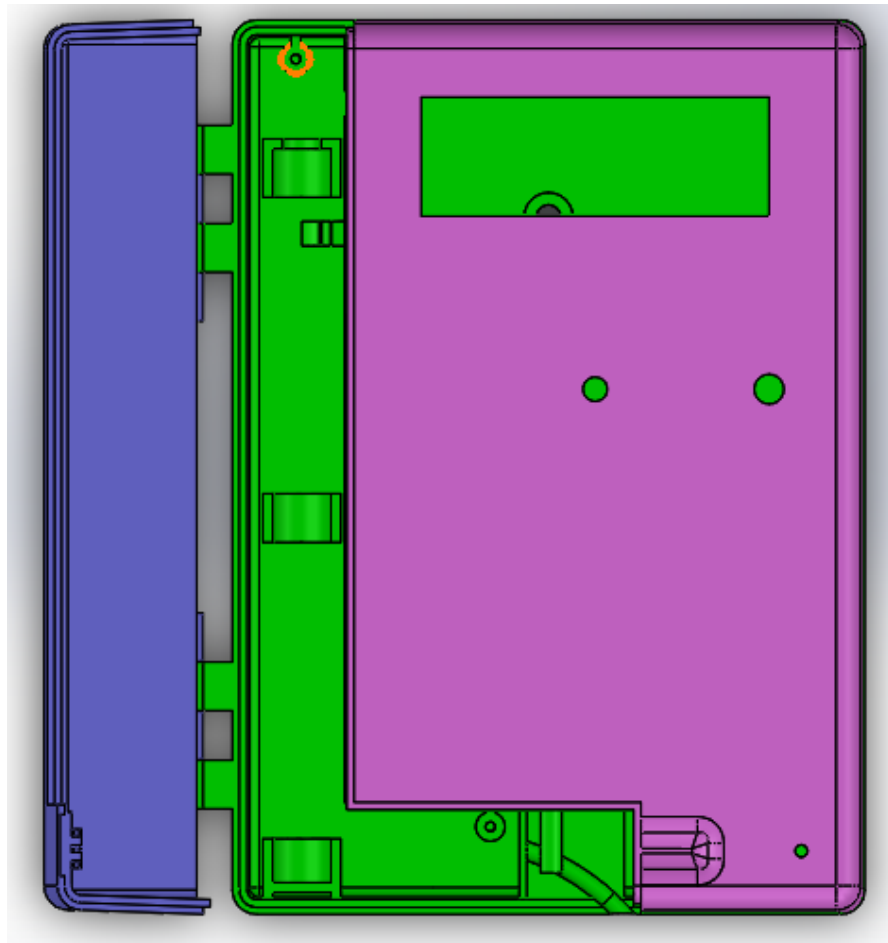

Differences between casing 1 and 2

The main difference between the two casings is the way the Arduino is laid out.

In casing 2 the IV line goes in top left, and comes out of the fluid warmer in the middle of the bottom. This is more practical because in Nepal the IV stand is not always on the same side of the bed. By having the output in the middle, it can never be on the wrong side.

The thickness of the casing has also changed. In casing 1 this was 2.5 mm, but casing 2 has a thickness of 3.0mm. This is thanks to feedback from Ram Chandra Thapa.

The top of casing 2 is fastened with just 1 screw, compared to 2 in the previous design.

Because of the different layout, the copper plate has also changed from fluid path 4 to fluid path 6. With this fluid path the IV line has more contact with the copper plate and this should improve the heating because more of the IV tube is in contact with the copper plate in this design. The copper plate is shown in figure 58. Appendix pg.47 shows the dimensions of this part. This is important for the people who are going to make it.



Figure 57 - Copper plate casing 2

The way the IV line exits the fluid warmer has also changed. It has a curve to prevent the IV line closing in on itself (figure59). The red rectangle shows the place for the second sensor, and the orange line shows the path of the IV line.

This part is bulky. But the extra ABS acts as an insulator for the sensor. This is important to ensure that the sensor has an accurate reading.

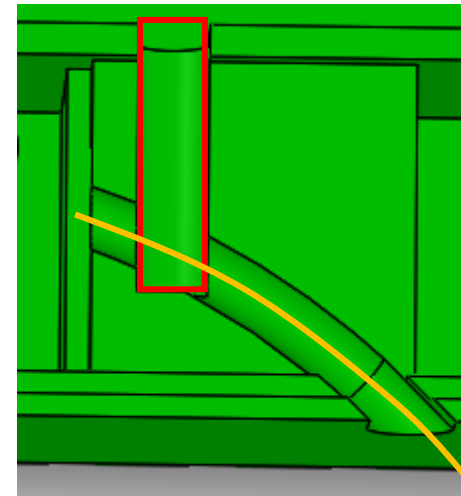

Figure 58 - IV line path

Feedback

Abi Bush was asked to give feedback on the casing, especially the simple design choices:

"I like the design. In this context it is better to have a robust design that is obvious how to use than a sleek design that is not obvious in use. The extra material in some places does not influence the printing time and won't raise the price of the product."

Adjustments

Holes need to be added in the bottom of the fluid warmer to be able to drain fluid if necessary.

It needs to be tested to see if insulation is needed or not.

Clamps can be added to distribute the wiring more efficiently.

7.8.4 Materials & manufacturing

These parts will be manufactured by 3D printing. This is a technique which can be open source. The parts will be printed in ABS, because this is readily available in Nepal and has a high melting point compared to other materials. The melting point of PLA is too low to be able to use with the heating element at 80°C.

7.8.5 Technical drawings

Manufacturing the fluid warmer for 3D printing is a completely different process to manufacturing products for injection moulding. Instead of using technical drawing to make clear how the product should be manufactured, the STL file is uploaded to an open source website. This eliminates the need for technical drawing. A detailed assembly chart is needed instead.

7.8.6 Conclusion

This casing can be 3D printed and be used in the hospital.

7.9 Assembly

The casing is made so the product can be easily assembled by anyone downloading the fluid warmer. Therefore, there needs to be a very easy to follow assembly chart. Even though the illiteracy rate in Nepal is very high, the chart contains words, at it can be assumed that anyone putting together the fluid warmer will be able to read.

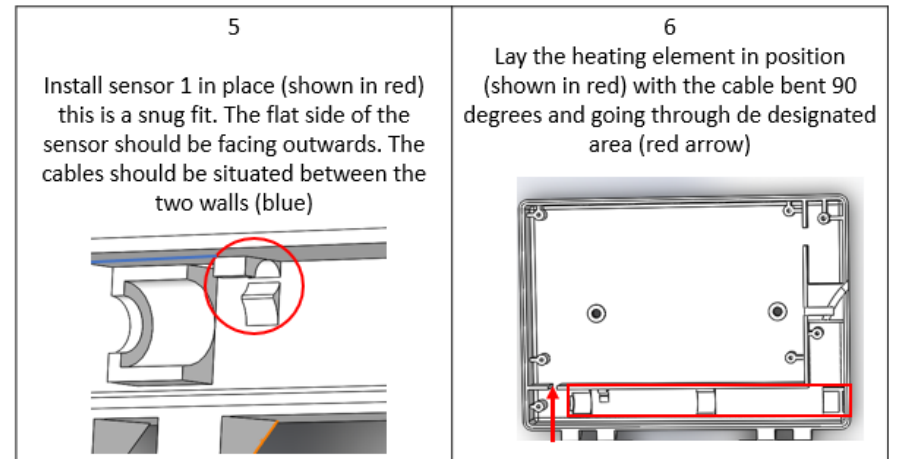
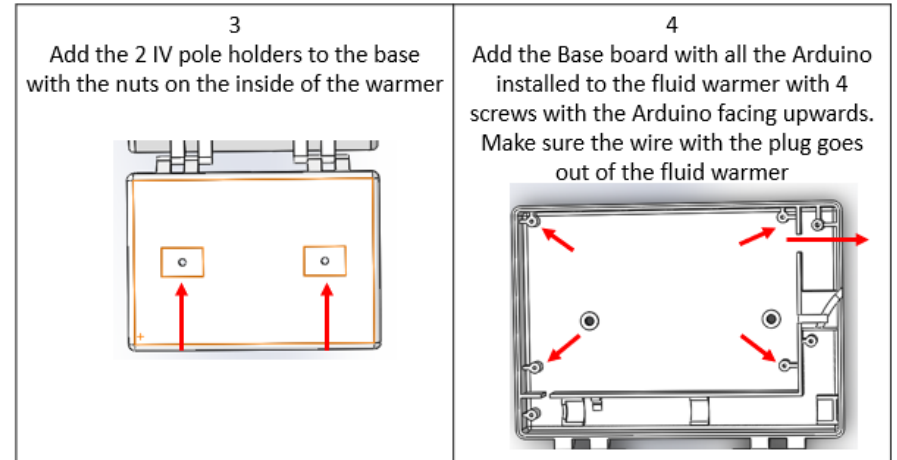
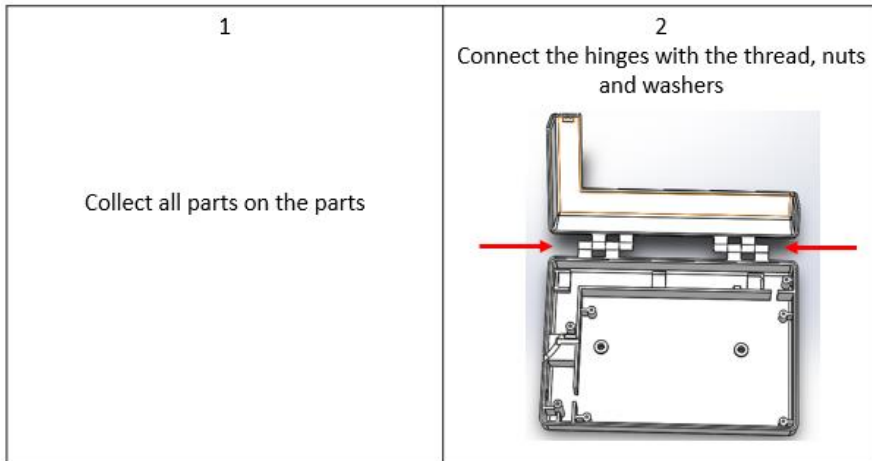

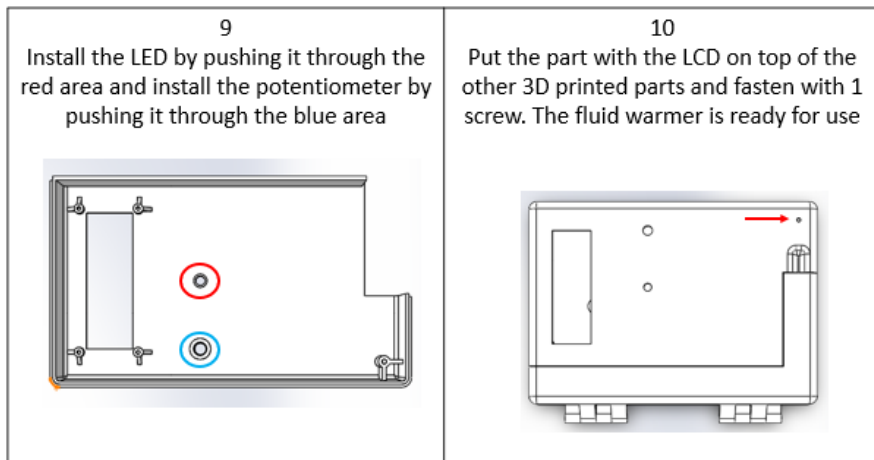
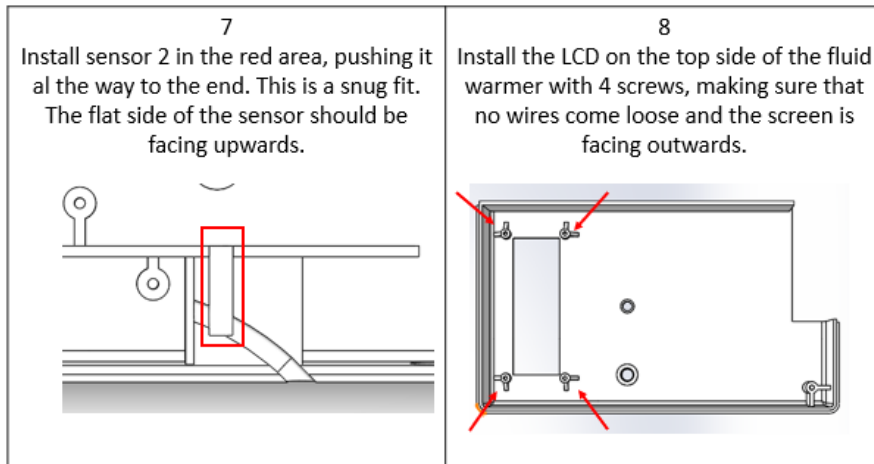

Adjustments

By making this guide with actual pictures of the parts instead of solid works, the instructions can become a lot clearer and it will be easier to follow along.

8. Verification

8.1 Introduction

This chapter shows various points of verification that have not yet been dealt with in the design stage of this thesis.

8.2 Cost analysis

The cost of the fluid warmer is calculated by adding up the totals of each part. This cost calculation does not add labour or machine cost, because these investments are what the clients are expected to have. The price of the fluid warmer is \$32.78, or €27.42.

Part	Price for 1	Source	Number needed	Total €	Total \$
3D printed parts					
bottom of the casing	504NPR	Market research	1x	4.14	4.95
top left of the casing	210NPR	Market research	1x	1.73	2.07
top right of the casing	336NPR	Market research	1x	2.76	3.30
Fastening					
M2.5 by 12mm screw	0.05EUR	(Accugroup, 2018)	8x	0.40	0.48
M5 by 25mm bolt	0.08EUR	(Accugroup, 2018)	6x	0.48	0.57
M5 nut	0.05EUR	(Accugroup, 2018)	2x	0.10	0.12
M5 winged nut	0.28EUR	(Accugroup, 2018)	4x	1.12	1.34
M3 by 25mm screw	0.15EUR	(Accugroup, 2018)	1x	0.15	0.18
M3 60 mm tread	0.19EUR	(Accugroup, 2018)	2x	0.38	0.45
M3 nut	0.04EUR	(Accugroup, 2018)	4x	0.16	0.19
M3 washer	0.04EUR	(Accugroup, 2018)	4x	0.16	0.19
Solder	0.06USD	(AliExpress, 2018)	10 grams	0.50	0.60
Arduino					
LED 5mm	0.03EUR	(AliExpress, 2018)	1x	0.03	0.04
LCD	1.98USD	(AliExpress, 2018)	1x	1.66	1.98
Temperature sensor	0.79USD	(AliExpress, 2018)	2x	1.32	1.58
Arduino Nano	2.28USD	(AliExpress, 2018)	1x	1.91	2.28
Resistor	0.01USD	(AliExpress, 2018)	2x	0.02	0.02
Voltage regulator	0.95USD	(AliExpress, 2018)	1x	0.79	0.95
Relay	0.95USD	(AliExpress, 2018)	1x	0.79	0.95
Rotary encoder	0.62USD	(AliExpress, 2018)	1x	0.52	0.62
Wires	0.02USD	(AliExpress, 2018)	30x	0.50	0.60
Board	1.05USD	(AliExpress, 2018)	1x	0.88	1.05
Heating element	700NPR	Market research	1x	5.76	6.89
Cable with plug	1.38USD	(AliExpress, 2018)		1.16	1.38
Total				€27.42	\$32.78

8.3 Electromagnetic interference (EMI)

All electronics send out a frequency. Some of these frequencies can mess with the electronics of other frequencies. To prevent the electronics in the fluid warmer from interfering with other medical equipment in the operating theatre a test for electromagnetic interference must be done. The equipment to do this test is very expensive, so it is done by companies who specialize in this matter. The fluid warmer needs to be sent to one of these companies to make sure that the product can be used in the operating theatre.

8.4 Open source availability

Providing the fluid warmer online does not come without risk. For example, the fluid warmer could be used for things it wasn't meant too, and the code could be changed to heat the fluids to unsafe temperatures. Therefore, there was decided to provide the casing online, and not the Arduino. To get the Arduino, the person who downloads the casing needs to contact Field Ready. Field Ready will then supply a waiver that this person must sign, stating that if they change the code, Field Ready cannot be held liable, and that they will only use the fluid warmer for its intended use. This waiver needs to be drafted by a professional in this field.

As of right now, the fluid warmer is not yet available on open source websites. This will become available after the safety measures stated previously are implemented and a document has been drafted to accompany the fluid warmer.

8.5 The field ready fluid warmer must be ready for use (35.2°C) in 189 seconds or less.

8.5.1 Introduction

The following calculations show the time it takes for the fluid warmer to warm at the lowest heating element temperature (37°C).

8.5.2 Formulas

To calculate how long it takes to heat the fluid warmer the following formulas were needed:

$$\dot{Q} = \frac{T_1 - T_2}{R}$$

$$R = \frac{l}{kA}$$

$$A = \text{length of tube} \cdot d\pi$$

$$\Delta T_2 = \frac{\dot{Q} \cdot \Delta t}{C_p}$$

$$C_p = c_p \cdot m$$

$$m = A \cdot l \cdot \rho_{\text{silicon}}$$

$$T_{2\text{New}} = T_{2\text{previous}} + \Delta T_2$$

\dot{Q} = Heat transfer rate in W (watt)

T_1 = Outside temperature (temperature of the heater) = 37°C

T_2 = Inside temperature (temperature of blood before heating) = 1°C

l = Thickness of IV tube in m (meter) = 0.0005m

k = Thermal conductivity of silicon rubber in W/mK (watt/meter kelvin) = 0.14 W/mK (Clemens J. M. Lasance, 2017)

A = Area of heat conduction

R = Thermal resistance K/W (kelvin/ watt)

Length of tube in m (meter) = 0.15m

d = Diameter in m (meter) = 0.0035m

Δ = Increment

t = time in s (second)

C_p = Heat capacity in J/K (joule/kelvin)

c_p = specific heat of silicon rubber in J/kgK (joule/kilogram kelvin) = 1300 J/kgK (AZO materials, 2017)

m = mass in kg (kilogram)

ρ = density of silicone rubber kg/m³ (kilogram /cubic meter) = 2300 kg/m³ (AZO materials, 2017)

8.5.3 Calculations

Calculations can be found in appendix pg.48. They show the time that it takes to warm the IV line. The heating element is up to temperature in 5 seconds. The thermal conductivity of copper is so high that the copper plate will be up to temperature at the same time as the heating element. It takes 15 + 5 seconds to heat the fluid warmer sufficiently.

These calculations were checked by Kieran Ram.

8.5.4 Conclusion

It takes 20 seconds to heat the fluid warmer sufficiently.

8.6 Checklist requirements

Requirements	Source	Complies	Almost complies	Does not comply
The Field Ready fluid warmer must be able to heat water and blood to from 1°C to 37°C at a flow rate of 6000 ml/h (100 ml/min).	Research 5.3 Research 5.5 Research 5.6			X
All parts needed to produce the fluid warmer must cost less than \$75 in total.	Research 5.4	X		
The field ready fluid warmer must be ready for use (35.2°C) in 189 seconds or less.	Research 5.4	X		
The Field Ready fluid warmer must be able to be acquired and produced in Nepal.	Research 5.4	X		
The maximum temperature the fluid can be heated to must not exceed 42°C.	Research 5.5	X		
The fluid warmer warms blood via the heating technique “dry heat”.	Research 5.5	X		
Doctors and nurses must be able to use the fluid warmer after a 15 minute instruction.	Research 5.5		X	
The fluid warmer must be open source.	Research 5.4		X	
Easily cleanable surface.	Research 5.6	X		
The fluid warmer has no direct contact with fluids.	Research 5.6	X		
A remote sensor may be used to control the heating, but such sensors shall not be used to control the maximum temperature that the fluid warmer can attain. That maximum temperature shall be controlled only as a result of measurements made by a sensor or sensors appropriately positioned in the fluid warmer.	Standard specifications	X		

Requirements	Source	Complies	Almost complies	Does not comply
Equipment or equipment parts shall be marked as follows: <ul style="list-style-type: none"> - Where appropriate: to warn against possible safety hazards from penetration by sharp objects - To specify, in the case of equipment parts supplied or controlled by an external sensing device, that the equipment shall only be used with the external sensing device specified by the manufacturer of the equipment 	Standard specifications	X		
Fluid warmers shall display set point temperature (The temperature, which may be operator adjustable, used by the fluid warmer as the desired temperature of the blood, intravenous solution or irrigation fluid, upon operator demand.) Fluid warmers with a fixed set point temperature shall be labelled with that value.	Standard specifications	X		
There shall be a visual temperature indicator capable of displaying the active controlled temperature (the temperature displayed by the fluid warmer and derived from a sensor in the fluid warmer).	Standard specifications	X		
Minimum resolution of the visual temperature indicator shall be 2 degrees C.	Standard specifications	X		
The visual temperature indicator shall have an accuracy of 2 degrees C or better.	Standard specifications	X		
Means for drainage of fluid leaking from the equipment shall be provided.	Standard specifications	X		

Requirements	Source	Complies	Almost complies	Does not comply
The fluid path (the channel through which the product intended for patient infusion or irrigation flows in-line (through a closed pathway) from its source (e.g., blood bag, intravenous solution bag, or irrigation fluid bag) to the patient) shall withstand 375mm Hg pressure or 1.25 times the manufacturer maximum recommended pressure, whichever is greater.	Standard specifications		X	
The fluid warmer shall not cause thermal haemolysis at levels that constitute a safety hazard.	Standard specifications	X		
The effectiveness of the independent thermal cut-out shall not be affected by any change or fault in the control thermostat and its associated system.	Standard specifications	X		
The fluid warmer shall not create output fluid temperatures (the temperature of the fluid at the exit of the fluid path) that cause thermal injury.	Standard specifications	X		
In addition to the control thermostat, an independent thermal cut-out shall be provided and set to operate so that a safety hazard (haemolysis and/or patient thermal injury) does not occur.	Standard specifications	X		
The fluid warmer must still be able to work normally after spillage on the surface of the fluid warmer.	Standard specifications	X		

Requirements	Source	Complies	Almost complies	Does not comply
<p>There must be an accompanying document containing instructions including the following:</p> <ul style="list-style-type: none"> - A recommendation that the equipment or equipment parts be checked for mechanical damage prior to each use. - If applicable, statements, details and warnings on the use of the fluid warmer in combination with other heat sources (i.e. preheated fluid bags). - Particulars of any necessary calibration procedure to be performed by the operator or user. - Information as to how to test an alarm system if the alarm system is not tested automatically when the equipment is switched on. - Information as to how the operator can confirm that the independent thermal cut-out (a safety device that interrupts electric current when the heater is heated to a certain degree) is functioning correctly. - If the fluid warmer contains a mains failure alarm, a statement to that effect. - Specify that perforation of the applied part containing an electrical component is a single fault condition and not to be used. 	Standard specifications		X	

Requirements	Source	Complies	Almost complies	Does not comply
Part of the fluid warmer can be 3D-printed	Research 5.8	X		
The fluid warmer has an interchangeable heating element.	Research 5.7		X	
The fluid warmer can work on different power sources	Research 5.6		X	

The fluid warmer does not comply to the following requirement

The Field Ready fluid warmer must be able to heat water and blood to from 1°C to 37°C at a flow rate of 6000 ml/h (100 ml/min).

Field Ready has decided not to heat the heating element above 80°C. furthermore the casing and IV line both have a maximum temperature. The chapter conclusion and recommendations further explains why the fluid warmer does not meet this requirement.

The fluid warmer almost complies to the following requirements

Doctors and nurses must be able to use the fluid warmer after a 15-minute instruction.

Er. Kishor Bhandari has mentioned that the fluid warmer can be used by the doctors and nurses after a 5-minute instruction. This is however not tested.

The fluid warmer must be open source.

Not all tests have been executed, after all the tests are done the fluid warmer will be uploaded.

There must be an accompanying document containing instructions.

A document has not yet been made. However, the instructions this document must contain have already been specified.

The fluid path (the channel through which the product intended for patient infusion or irrigation flows in-line (through a closed pathway) from its source (e.g., blood bag, intravenous solution bag, or irrigation fluid bag) to the patient) shall withstand 375mm Hg pressure or 1.25 times the manufacturer maximum recommended pressure, whichever is greater.

This test has not yet been executed due to lack of equipment. It is however highly unlikely that this test will fail, because this is a test of the IV line, not the fluid warmer itself.

The fluid warmer almost complies to the following wishes

The fluid warmer has an interchangeable heating element.

At the moment the heating element can only be exchanged with a heating element with the same diameter and an extra 25mm or a version that is 10 mm shorter.

The fluid warmer can work on different power sources.

The fluid warmer has an electrical plug. If this plug is removed and the wires are exposed, the fluid warmer could also be used with a car battery as a power source due to the voltage regulator. This has however not been tested.

9. Conclusion and recommendation

To answer the main question; yes, it is possible to design a low-cost fluid warmer that can be made available on open source websites.

This is done by making a 3D-printable fluid warmer casing, with Arduino electronics.

The fluid warmer does not meet the requirement of being able to warm blood at a flowrate of 100ml/min. This is mostly due to the decision that the heating element cannot exceed 80°C. Due to all the safety features that have been added the temperature of the heating element would be able to safely exceed 80°C. With some changes in the code the heating element can go up to 200°C. This is the maximum temperature IV line can safely withstand (Shinetsu Silicone, 2017). The length of IV line that can be inside the fluid warmer should also be increased to 35cm. With these changes the fluid warmer will be able to heat the blood to 28.2°C. The calculations can be found in appendix pg.52. However, ABS becomes pliable at 105°C (Rahman, Schott, & Kanta Sadhu, 2018). The ABS casing would not be able to withstand the temperature of the heating element at 200°C. Therefore, the temperature of the heating element should never exceed 100°C. With this temperature, at a flowrate of 100ml/min, the temperature of the blood will be 14.5°C.

The price of the fluid warmer is \$32.78. This is far below the maximum \$75 mark that was stated at the start of this project.

Most design choices were made for their practicality and simplicity. When dealing with a very high-risk project like this it is important to stay on the safe side rather than going for originality and unproven options.

The following statements are the next steps for the fluid warmer:

In this thesis all the tests have been executed with water. Before the fluid warmer becomes available, these tests must also be done with blood.

For the IV pole holder it is recommended to work together with students of Rotterdam University who have been working on a similar project.

A stress test should be executed to make sure the fluid warmer can withstand the forces that are applied to it during use.

A practical test need to be executed to ensure that the calculations are a good estimate for the actual temperature of the fluid that is being warmed. The difference between the outside temperature of the IV line and the temperature of the fluid inside should also be measured.

A test needs to be done were people put together the fluid warmer following the assembly guidelines and there needs to be assessed if the end product is up to par.

10. Reflection

Moving to Nepal to do my graduate internship is one of the best thing I have ever done, but also one of the hardest. It was a huge challenge to pack up my stuff and move away from family and friends to a country I had never been too and knew nobody. I am really proud to say that I had an amazing time in Nepal. Meeting new people, doing a job that I love was a great experience and I learned a lot about myself. I have gained a lot of confidence over the last couple of months and now know what I want to do once I graduate.

Working in Nepal is quite different than working in The Netherlands. Different office hours, everyone is always late for everything, power outages, and not being able to just order parts online are just a couple of things that made working challenging. I had to adapt to a new culture and speak English in the office. All things I wasn't used too. But after just a couple of weeks these things become normal and part of everyday life. I think it will be difficult for me to go back to being everywhere on time in The Netherlands!

One of the first things I learnt to do was to perform a risk assessment. This is something that I hadn't been taught at school but is really important for the design process, especially for designing medical equipment. I think knowing how to do a risk assessment will be very useful for me in the future.

My colleagues at Field Ready have been amazing over the last couple of months, especially the Nepal team. They made me feel at home from day one and have been a big part of what made my stay in Nepal so much fun. Field Ready has been working on some great projects while I have been with them and I noticed that it was difficult for me to only focus on my own project. I couldn't help but get involved with some other projects, including doing a needs-assessment in a flood affected area of Nepal. This

may have taken away some time from writing my thesis, but I think that the experience I gained while doing this needs-assessment is very valuable as well.

I also worked together with people outside of Field Ready. This wasn't always easy. One of the biomedical engineers was hard to work with because of professional jealousy. He wouldn't answer questions. This was hard to deal with at first, but by getting to know him better and by keep asking questions, not only about things that I needed to know for the project, but also about the projects he was working on and showing enthusiasm about his projects, I was able to overcome this.

As I mentioned before, everything is late in Nepal. This includes the Arduino code that I outsourced to a professional. The deadline that I stated was two weeks before leaving Nepal. But after repeated ignored calls and visits, I received the Arduino at 17:30 on Friday, and was on my way to the airport to leave for The Netherlands at 17:45 the same day. This made my last week in Nepal very stressful.

Going to a hospital in Nepal for the first time to look around was a huge eye-opener for me. The building was in pretty bad shape, with mould on the walls and ceilings of most of the rooms, and wires sticking out of the walls was shocking to see. But at the same time speaking to the doctors and biomedical engineers was amazing. The passion they have for helping their patients, no matter what conditions they needed to work in was really admirable and inspirational. It made me want to work just as hard to be able to help these patients, that often can barely afford a much-needed doctor visit due to the lack of health insurance in Nepal. I was really inspired to make the fluid warmer as cheap as possible.

I have learned a lot in the past couple of months and hope that my thesis reflects this. I am looking forward to going back to Nepal in February for a job at Field Ready!

Bibliography

AABB. (2017, October 10). *PDF: Guidelines for the use of blood warming devices*. Retrieved from AABB:
<https://www1.cgmh.org.tw/intr/intr2/c3920/bb/輸血加溫器使用之指導方針.pdf>

Accugroup. (2018, 01 10). *3mm x 25mm Phillips Pan Head Plastite (30) Screws - A2 Stainless Steel*. Retrieved from Accugroup:
https://www.accu.co.uk/en/plastite-30-phillips-pan-head-screws/371326-SIP30-3-25-A2?google_shopping=1&c=1&mkwid=s_dc&pcriid=209964354662&keyword=&match=&plid=&gclid=Cj0KCQiAkNfSBRCsARISAL-u3X9Q3osEZKQx0R92_VhK0RRjDijHrtPsB14mxol5858YUGP2t9o9_HlaAvWGEALw_wcB

Accugroup. (2018, 01 10). *M2.5 x 12mm Phillips Pan Head Screws (DIN 7985H) - A2 Stainless Steel*. Retrieved from Accugroup:
https://www.accu.co.uk/en/phillips-pan-head-screws/65378-SIP-M2-5-12-A2?google_shopping=1&c=1&mkwid=s_dc&pcriid=209968311797&keyword=&match=&plid=&gclid=Cj0KCQiAkNfSBRCsARISAL-u3X8XosEvCusw7lo6BBCZmClGpfv6nNMKV17qiP0xHdBLzuWnuRS SDHcaAnbpEALw_wcB

Accugroup. (2018, 01 10). *M3 Form A Flat Washers (DIN 125) - A2 Stainless Steel*. Retrieved from Accugroup:
<https://www.accu.co.uk/en/flat-washers/72482-HPW-M3-A2>

Accugroup. (2018, 01 10). *M3 Hexagon Nuts (DIN 934) - A2 Stainless Steel*. Retrieved from Accugroup: <https://www.accu.co.uk/en/hexagon-nuts/7888-HPN-M3-A2>

Accugroup. (2018, 01 10). *M3 x 1000mm Threaded Bars (DIN 975) - A4 Stainless Steel*. Retrieved from Accugroup:
https://www.accu.co.uk/en/threaded-bars/14734-HTB-M3-1000-A4?google_shopping=1&c=1&mkwid=s_dc&pcriid=209964354662&keyword=&match=&plid=&gclid=Cj0KCQiAkNfSBRCsARISAL-u3X-r_vaDfBTs-cYrdw6gGkEe0tfYm4GsXiVT8FCoPW1UrTkznJ9AQ2YaAtprEALw_wcB

Accugroup. (2018, 01 10). *M5 Hexagon Nuts (DIN 934) - A2 Stainless Steel*. Retrieved from Accugroup: <https://www.accu.co.uk/en/hexagon-nuts/7891-HPN-M5-A2>

Accugroup. (2018, 01 11). *M5 Wing Nuts (DIN 315 AF) - A2 Stainless Steel*. Retrieved from Accugroup: https://www.accu.co.uk/en/wing-nuts/8036-HWN-M5-A2?google_shopping=1&c=1&mkwid=s_dc&pcriid=209947483437&keyword=&match=&plid=&gclid=Cj0KCQiAkNfSBRCsARISAL-u3X9-kW6podZqjP2-Kl6wlvGY0MDyp-8eL2qVC37-fL4N4lxXWJfupkwaAjG_EALw_wcB

Accugroup. (2018, 01 10). *M5 x 25mm Full Thread Hexagon Bolts (DIN 933) - A2 Stainless Steel*. Retrieved from Accugroup:
<https://www.accu.co.uk/en/full-thread-hexagon-bolts/18847-SEBF-M5-25-A2>

AliExpress. (2018, 01 11). *10pcs/lot 8X12 cm double-Side Copper prototype pcb 8*12 cm Universal Board for Arduino Free Shipping Wholesale*. Retrieved from AliExpress:
<https://nl.aliexpress.com/item/10pcs-lot-8X12-cm-double-Side-Copper-prototype-pcb-8-12-cm-Universal-Board-for-Arduino/32715323068.html?spm=a2g0z.10010108.1000016.1.5a25ae33mYn1le&isOrigTitle=true>

AliExpress. (2018, 01 11). *1pcs EU Plug AC Power Cord Cable 1m 100cm 3 plug contacts LED light 2835 5050 power adapter EU plug cable Charging line*. Retrieved from AliExpress: <https://nl.aliexpress.com/item/1pcs-EU-Plug-AC-Power-Cord-Cable-1-2m-120cm-3-plug-contacts-for-LED-strip/32757333129.html?spm=a2g0z.10010108.1000016.1.30f597cebUWK2Y&isOrigTitle=true>

AliExpress. (2018, 01 10). *1PCS LCD module Blue screen IIC/I2C 1602 for arduino 1602 LCD UNO r3 mega2560*. Retrieved from AliExpress: <https://nl.aliexpress.com/item/1PCS-LCD-module-Blue-screen-IIC-I2C-1602-for-arduino-1602-LCD-UNO-r3-mega2560/32763867041.html?spm=a2g0z.10010108.1000016.1.2891f750tIZWK8&isOrigTitle=true>

AliExpress. (2018, 01 11). *1Set Wemos D1 Mini Relay Shield One Channel Wemos D1 Mini Relay Module For Arduino ESP8266 Development Board Free Shipping*. Retrieved from AliExpress: <https://nl.aliexpress.com/item/1PCS-NEW-Relay-Shield-for-Arduino-WeMos-D1-Mini-ESP8266-Development-Board-WeMos-D1-Relay-Module/32737849680.html?spm=a2g0z.10010108.1000016.1.7396801fsuhjd3&isOrigTitle=true>

AliExpress. (2018, 01 11). *360 Degrees Rotary Encoder Module For Arduino Brick Sensor Switch Development Board KY-040 With Pins*. Retrieved from AliExpress: <https://nl.aliexpress.com/item/Rotary-Encoder-Module-Brick-Sensor-Development-Board-For-Arduino/32224563961.html?spm=a2g0z.10010108.1000016.1.19c27617KetScx&isOrigTitle=true>

AliExpress. (2018, 01 10). *375 stks/125 stks 5 Kleuren 3mm 5mm Ronde Helder Licht LED Assortiment Kit Rood/Groen/wit/Geel/Blauw*

voor Arduino Raspberry Pi 3 2. Retrieved from AliExpress: https://nl.aliexpress.com/item/375pcs-5-Colors-3mm-5mm-Round-Bright-Light-LED-Assortment-Kit-Red-Green-White-Yellow/32815939257.html?src=google&albslr=221224290&isdl=y&aff_short_key=UneMJZVf&source=%7Bifdyn:dyn%7D%7Bifpla:pla%7D%7Bifdbm:DBM&albch=DID%7D&s

AliExpress. (2018, 01 11). *AC-DC 5V 700mA 3.5W Precision Buck Converter AC 220v to 5v DC step down Transformer power supply module for Arduino hot sale*. Retrieved from AliExpress: <https://nl.aliexpress.com/item/5V-700mA-3-5W-AC-DC-Precision-Buck-Converter-AC-220v-to-5v-DC-step-down/32677330307.html?spm=a2g0z.10010108.1000016.1.3d598d4c5V78Mp&isOrigTitle=true>

AliExpress. (2018, 01 11). *Best Price 100pcs resistor pack 10k ohm 1/4W 10k Metal Film Resistor 10kohm 0.25W 1% For Arduino UNO 2560 R3 Kit Free Shipping*. Retrieved from AliExpress: <https://nl.aliexpress.com/item/Best-Price-100pcs-resistor-pack-10k-ohm-1-4W-10k-Metal-Film-Resistor-10kohm-0-25W/32524294076.html?spm=a2g0z.10010108.1000016.1.35c653edmW2dtY&isOrigTitle=true>

AliExpress. (2018, 01 11). *Dupont Line 120pcs 10cm Male to Male + Male to Female and Female to Female Jumper Wire Dupont Cable for Arduino*. Retrieved from AliExpress: <https://nl.aliexpress.com/item/Dupont-Line-120pcs-10cm-Male-to-Male-Male-to-Female-and-Female-to-Female-Jumper-Wire/32829927834.html?spm=a2g0z.10010108.1000016.1.35bdd082FrSeMp&isOrigTitle=true>

AliExpress. (2018, 01 11). *MINI USB Nano V3.0 ATmega328P CH340G 5V 16M Micro-controller board for arduino NANO 328P NANO 3.0*

Retrieved from AliExpress: <https://nl.aliexpress.com/item/MINI-USB-Nano-V3-0-ATmega328P-CH340G-5V-16M-Micro-controller-board/32699243759.html?spm=a2g0z.10010108.1000016.1.5c8421cfFwuZxV&isOrigTitle=true>

AliExpress. (2018, 01 10). *New 1PCS Imported DALLAS DS18B20 18B20 18S20 TO-92 IC CHIP Thermometer Temperature Sensor for Arduino*. Retrieved from AliExpress: <https://nl.aliexpress.com/item/New-1PCS-Imported-DALLAS-DS18B20-18B20-18S20-TO-92-IC-CHIP-Thermometer-Temperature-Sensor-for-Arduino/32599936268.html?spm=a2g0z.10010108.1000016.1.758cde1f9Zairv&isOrigTitle=true>

AliExpress. (2018, 01 11). *Solder Wire 41SN Pure Tin 0.5mm 75g wire silver solder tin lead free electric soldering*. Retrieved from AliExpress: <https://nl.aliexpress.com/item/Solder-Wire-41SN-Pure-Tin-0-5mm-75g-wire-silver-solder-tin-lead-free-electric-soldering/32671789117.html?spm=a2g0z.10010108.1000016.1.d e776e5UyaLXn&isOrigTitle=true>

AM Harris, C. A. (2012, October 16). Guideline on the Administration of Blood Components. *British Committee for Standards in Haematology*, 51. Retrieved from BSH: http://www.bsh.org.uk/media/5152/admin_blood_components-bcsh-05012010.pdf

American Red Cross. (2017, October 06). *Blood Components*. Retrieved from American Red Cross: <http://www.redcrossblood.org/learn-about-blood/blood-components>

American Red Cross. (2017, October 06). *Types of donations*. Retrieved from American Red Cross:

http://www.redcrossblood.org/donating-blood/types-donations#whole_blood

ATI nursing education. (2017, October 05). *Intravenous solutions*. Retrieved from ATI nursing education: https://atitesting.com/ati_next_gen/skillsmodules/content/iv-therapy/equipment/iv-solutions

AZO materials. (2017, November 06). *Silicone Rubber*. Retrieved from AZOM: <https://www.azom.com/properties.aspx?ArticleID=920>

Baxter Healthcare Corporation. (2017, October 05). *Dextrose 5 in .9 sodium chloride*. Retrieved from rxlist: <https://www.rxlist.com/dextrose-5-in-9-sodium-chloride-drug.htm>

Bickford Science. (2017, November 14). *Specific Heat & Temperature*. Retrieved from www.bickfordscience.com: http://www.bickfordscience.com/03-05_State_Changes/PDF/Specific_Heat.pdf

Blake, A., Petley, G., & Deakin, C. (2000). Effects of changes in packed cell volume on the specific heat capacity of blood: implications for studies measuring heat exchange in extracorporeal circuits. *British Journal of Anaesthesia*, Jan;84(1):28-32.

Clemens J. M. Lasance . (2017, November 06). *The thermal conductivity of rubbers/elastomers*. Retrieved from Electronic Cooling: <https://www.electronics-cooling.com/2001/11/the-thermal-conductivity-of-rubbers-elastomers/>

Daraz. (2018, 01 10). *Baltra Immersion Water Heater Rod*. Retrieved from Daraz: <https://www.daraz.com.np/baltra-immersion-water-heater-rod-42592.html>

- Gamgee, A. (1870). The Specific Heat of Blood. *Journal of Anatomy and Physiology* , 139-141.
- Health Devices. (1996). In-line blood/solution warmers. *Health Devices*, Abstract.
- health.gov. (2017, October 05). *PDF: 10% Dextrose Injection (Dextrose in Water) in Plastic Bags*. Retrieved from health.gov: <https://www.old.health.gov.il/units/pharmacy/trufot/alonim/1574.pdf>
- Herron DM, G. R. (1997). The limits of bloodwarming: maximally heating blood with an inline microwave bloodwarmer. *J Trauma*, 43(2):219-26.
- Hospira. (2017, October 05). *potassium chloride in sodium chloride (Potassium Chloride and Sodium Chloride) injection, solution* . Retrieved from NIH: <https://dailymed.nlm.nih.gov/dailymed/archives/fdaDrugInfo.cfm?archiveid=1321>
- IT IS Foundation. (2017, November 14). *Thermal Conductivity*. Retrieved from www.itis.ethz.ch: <https://www.itis.ethz.ch/virtual-population/tissue-properties/database/thermal-conductivity/>
- Medical Dictionary. (2017, October 10). *Haemolysis*. Retrieved from Medical Dictionary: <http://medical-dictionary.thefreedictionary.com/haemolysis>
- Merriam-Webster Medical Dictionary. (2017, October 06). *Whole Blood*. Retrieved from Merriam-Webster Medical Dictionary: <https://www.merriam-webster.com/medical/whole%20blood>
- Ogbru, O. (2017, October 05). *sodium chloride solution (intravenous)*. Retrieved from Medicinenet: https://www.medicinenet.com/sodium_chloride_solution-intravenous/article.htm
- Rahman, M., Schott, N., & Kanta Sadhu, L. (2018, 01 07). *Glass Transition of ABS in 3D Printing*. Retrieved from Cosmol: https://www.comsol.it/paper/download/361301/rahman_paper.pdf
- Red Cross. (2017, October 10). *Reasons People Recieve Blood Transfusions*. Retrieved from Red Cross: <http://www.redcrossblood.org/learn-about-blood/blood-transfusions/reasons-people-receive>
- Red Cross. (2017, October 10). *The Process*. Retrieved from Red Cross: <http://www.redcrossblood.org/learn-about-blood/blood-transfusions/the-process>
- Requirements for Storage, Transportation and Expiration. (2016). In AABB, *AABB Standards for Blood Banks and Transfusion Services, 30th Edition* (pp. 51-60).
- Samir M Fakhry, P. F. (2004). How low is too low? Cardiac risks with anemia. *Critical Care*, S11–S14.
- Shinetsu Silicone. (2017, 01 06). *Characteristics properties of silicone rubber compounds*. Retrieved from shinetsusilicone-global: https://www.shinetsusilicone-global.com/catalog/pdf/rubber_e.pdf
- Shmukler, M. (2017, November 14). *Density of Blood*. Retrieved from hypertextbook.com: <https://hypertextbook.com/facts/2004/MichaelShmukler.shtml>

Stihler Electronics. (2017, October 11). *PDF: Astotherm plus*. Retrieved from Stihler Electronics:
<http://www.stihlerelectronic.de/docs/en/Leaflet%20Astotherm%20Plus,%20English.pdf>

World Health Organization Blood Transfusion Safety. (2002). Warming blood. In World Health Organization Blood Transfusion Safety, *The Clinical Use Of Blood Handbook* (p. 55).